

South Carolina Driver's Manual

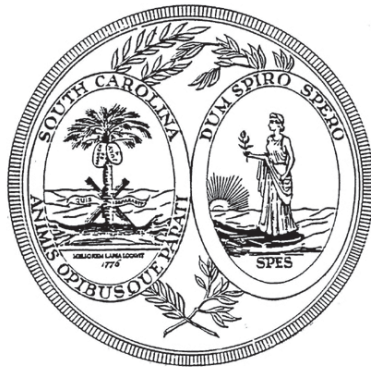

South Carolina Department of Motor Vehicles



Table of Contents

Letter From The Director	2
■ Introduction To Driver's License	7
The Rules of The Road	8
Classes of Licenses	8
Identification Cards	9
Beginner Permits	9
Conditional License	10
Special Restricted License	11
Regular Driver's License	12
Newcomers and Non-Residents	12
The Licensing Procedure	13
Medical Conditions	13
License Expiration	14
Documents You Will Need	15
Applicants From Other Countries	18
Change of Address or Name	19
Destroyed or Lost License	20
Motor Voter	21
Fraudulent Documents	21
■ General Information	23
Traffic Safety Rules	24
Speed	24
Speed Limits	24
Stop at Grade Crossings	25
Stopped School Bus	26
Parking and Leaving A Vehicle	28
Places You Should Not Park	28
Entering and Starting a Parked Vehicle	29
The Faster You Go	29
The Killing Speed	30
Driving Too Slowly	30

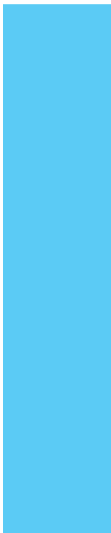





DISCLAIMER:

The state motor vehicle laws that are mentioned in this book are not reproduced in their entirety and the wording is not identical. Due to possible legislative changes in federal and state law and SCDMV Policy, the information in this manual may not always be current. SCDMV will make every effort to incorporate any changes as soon as possible.

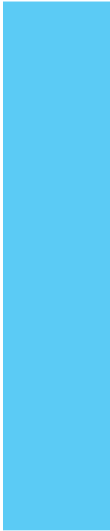
**For more information, please visit our website at:
www.scdmvonline.com**







Traffic Signs, Signals and Pavement Markings	31
Obey Traffic Officers	32
Emergency Vehicles and Scenes	32
Driving at Night	32
What to Do in Case of an Accident	33
How to Avoid Accidents	35
Driving Emergencies	35
Weather Changes Call For Safe Driving	38
Winter Driving Techniques	39
Driving in Fog	39
Driving in Smoke	40
Flooded Roads	40
Know Your Vehicle	41
Illegal Equipment	43
Safety Belts Save Lives	44
Child Restraint	44
Sharing the Road	45
Littering is Against the Law	53
Driving Tips for Mature Drivers	54
Drugs and Driving	55
Keeping Your License	57
Driving Under the Influence	64
Insurance and Financial Responsibility	66
Cars: The Road Test	69
What the Examination Involves	70
Road Test	70
Steering a Vehicle	72
Manual Transmission	75
Turning Your Vehicle	77
When to Use Your Horn	83
Signals for Stops, Lane Changes and Turns	83
Stopping	84
Following Other Cars	85
Parking	86
Yielding Right of Way	87
Important Lane Passing Skills	88
Interstate Driving	94
Tips for Interstate Driving	98
Primary Highway Driving	98
Secondary Road Driving	98
Proper Method of Braking	99
Trucks and Recreational Vehicles.....	101
Truck Class Licenses	102
The Licensing Procedures	103
Driving Requirements	103



	Proper Driving Techniques	105
	Routine Truck Driving Tasks	111
	Hooking Up/Unhooking Requirements	120
	Specific Maneuvers Required During the Test	121
	Motorcycles	131
	How to Get a License/Permit	132
	Getting to Know Your Motorcycle	132
	Preparing to Ride: Protective Clothing	135
	You Have Chosen a Motorcycle	137
	Motorcycle Safety	139
	Seeing and Being Seen	139
	How to Avoid Trouble	142
	Handling Hazards and Dangerous Surfaces	147
	Motorcycling Laws and Information	151
	Motorcycle with Sidecar Skills Test	159
	Mopeds.	165
	Moped Riding in South Carolina	166
	What is a Moped?	166
	Moped Equipment	167
	The Moped Operator	167
	Obtaining a Moped License	167
	Special Regulations	168
	Safety	169
	Traffic Signs, Signals, and Markings	171
	Regulatory Signs	172
	Warning Signs	176
	Guide Signs	181
	Route Markers	183
	Pavement Markings	186
	Signals	191
	Finding Your Local DMV	195



NOTE: Each section of this manual is color coded for easy reference. Color bars can be found above the page number on each page.

	Introduction To Driver's License	LIGHT BLUE
	General Information	GRAY
	Cars: The Road Test	BLUE
	Trucks	YELLOW
	Motorcycles	GREEN
	Mopeds	PURPLE
	Traffic Signs, Signals, Markings	RED



Introduction To Driver's License



The Rules of The Road

This book is your guide to good driving. It explains the rules of the road and what the law expects of you as a driver.

The purpose is to help you learn traffic-control devices, signs and pavement markings, which you must know before you get on the highway.

Classes of Licenses

SC issues licenses as proof that you've been examined and are qualified to operate a particular type of vehicle. The class license you will need is based on the gross vehicle weight rating (GVWR) or gross vehicle weight (GVW).

Commercial Licenses

- **Class A:** Any combination of vehicles with a GCWR of 26,001 or more pounds provided the GVWR of the vehicle(s) being towed is in excess of 10,000 pounds.
- **Class B:** Any single vehicle with a GVWR of 26,001 or more pounds, or any such vehicle towing a vehicle not in excess of 10,000 pounds GVWR.
- **Class C:** Any single vehicle, or combination of vehicles, that does not meet the definitions of Class A or B, but either is designed to transport 16 or more passengers, including the driver, or is placarded for hazardous materials.

Non-Commercial Licenses

- **Class D:** Allows you to drive non-commercial passenger vehicles, such as cars and trucks, which do not exceed 26,000 pounds gross vehicle weight. With a Class D driver's license, you may also operate a three-wheel vehicle (excluding a two-wheel motorcycle with a side car).
- **Class E:** Allows you to operate non-commercial, single unit vehicles that exceed 26,000 pounds gross vehicle weight. Examples of Class E vehicles include trucks and motor homes. With a Class E driver's license, you may also operate a three-wheel vehicle (excluding a two-wheel motorcycle with a side car).
- **Class F:** Allows you to drive non-commercial, combination vehicles that exceed 26,000 pounds gross vehicle weight. Examples of Class F vehicles include trucks and motor homes with a towed trailer or vehicle. With a Class F driver's license,

you may also operate a three-wheel vehicle (excluding a two-wheel motorcycle with a side car).

- **Class M:** Allows you to operate a two-wheel motorcycle, a two-wheel motorcycle with a detachable side car, or a three-wheel vehicle.
- **Class G:** Allows you to operate a moped. If you have a valid driver's license or permit in any of the other four classifications, you will not be required to obtain a license to drive a moped. (Minimum age 14)

Each qualified driver will have only one driver's license, endorsed for one or more of the classifications. It is illegal to have more than one valid driver's license. If you drive a motorcycle and another type of vehicle, your license will be endorsed for two classifications, after completion of driving tests for both types of vehicles. A moped Class G license requires a vision and knowledge test only.

When driving you must have a valid driver's license, vehicle registration and valid insurance card in your possession for the class of vehicle you are operating. If you do not, you may be subject to a fine.

Identification Cards

Identification cards are issued to residents who are at least five years of age. For United States citizens, the card expires five years after the issue date. For non-United States citizens, the card expires at the end of the applicant's authorized period of stay in the United States or the expiration date on the employment authorization document. The same documentation used when obtaining a first-time driver's license or beginner's permit is required when obtaining a first time I.D. card.

Beginner's Permit

To apply for a beginner's permit, you must be at least 15 years of age or older. You must provide a birth certificate, social security card or its equivalent, proof of residency, and must pass the vision and knowledge tests. If you are under 18 years of age, you must have a parent or legal guardian sign your application.

If you have a valid out-of-state beginner's permit, you may obtain a beginner's permit in this state. The time you held your out-of-state permit also counts toward the 180 day requirement. If your permit has expired, however, you must take the vision and knowledge tests to get a S.C. beginner's permit.

Regardless of your age, if you have never been licensed or do not have proof of past driving experience, you must hold your beginner's permit for 180 days before being eligible for a driver's license.

With a beginner's permit, you may:

- Operate a motor vehicle from 6 a.m. to midnight with a licensed driver who is at least 21 years old, who has at least one year of driving experience, and who is sitting in the front seat with you.
- Drive motorcycles, motor scooters or light motor driven cycles from 6 a.m. to 6 p.m. (8 p.m. during daylight savings time). You may not operate a motorcycle, motor scooter or light motor driven cycle at any other time with a beginner's permit unless you are supervised by a Class M licensed parent or guardian. If you are operating a three-wheeled vehicle, the driver accompanying you must be directly behind you on a saddle-type seat or beside you on a bench type seat.
- Your driving privileges will be suspended for six months if you receive traffic violations totaling six or more points.

For information concerning Commercial Beginner's Permit requirements, refer to the SC Commercial Driver's License Manual.

Conditional License

To apply for a Conditional Driver's license, you must be at least 15 years of age and less than 16 years of age and have held your beginner's permit for at least 180 days. You must also bring your insurance information, your parent or guardian to sign your application, and Form PDLA that certifies you have:

- 1) Completed a driver's education course,
- 2) Had satisfactory school attendance,
- 3) Practiced driving with your parent or legal guardian for at least 40 hours, including 10 hours of driving practice at night.

Form PDLA allows you to submit all of these certifications and is available at your school and the SCDMV web site at www.scdmsonline.com. When you apply for your conditional license, you will also have to pass the vision and road test.

If you have a conditional driver's license, you may drive alone during daylight hours. In SC, daylight hours are defined as 6 a.m. to 6 p.m., or 6 a.m. to 8 p.m. during daylight savings time. You may drive after daylight hours until midnight while accompanied by a licensed driver that is at least 21 years of age or older. If you drive after midnight, you must be accompanied by a licensed parent or guardian.

With a conditional license, you cannot transport more than two passengers who are under the age of 21 unless you are accompanied by a licensed adult who is at least 21 years old. The only exception is if

you are transporting family members or students to and from school.

You may obtain full driving privileges when you are 16 if you have had your license for one year and have no traffic offenses or been involved in any at-fault accidents. Your driving privileges will be suspended for six months if you receive traffic violations totaling six or more points.

Special Restricted License

To apply for a Special Restricted Driver's license, you must be at least 16 years of age and less than 17 years of age and have held your beginner's permit for at least 180 days or have a conditional license. You must bring your insurance information and your parent or guardian to sign your application. You must also submit Form PDLA that certifies you have:

- 1) Completed a driver's education course,
- 2) Had satisfactory school attendance,
- 3) Practiced driving with your parent or legal guardian for at least 40 hours, including 10 hours of driving practice at night.

Form PDLA allows you to submit all of these certifications and is available at your school and the SCDMV web site at www.scdmvonline.com. When you apply for your special restricted license, you will also have to pass the vision and road test.

If you have a special restricted driver's license, you may drive alone during daylight hours. In SC, daylight hours are defined as 6 a.m. to 6 p.m., or 6 a.m. to 8 p.m. during daylight savings time. You may drive after daylight hours until midnight while accompanied by a licensed driver that is at least 21 years of age or older. If you drive after midnight, you must be accompanied by a licensed parent or guardian.

If the time limitations cause problems for you at your job or school, they may be waived. You must prove to the department that they interfere with your job, education or travel between home, school, vocational training or employment opportunities by submitting two statements:

1. A statement from your parent or legal guardian, and
2. A statement from your employer or school official.

Both statements must give the reason for the waiver. The waiver will not allow you to drive after midnight.

With a special restricted license, you cannot transport more than two passengers who are under the age of 21 unless you are accompanied by a licensed adult who is at least 21 years old. The only exception is if you are transporting family members or students to and from school.

You may obtain full driving privileges when you are 16 if you have had your license for one year and have no traffic offenses or been

involved in any at-fault accidents. Your driving privileges will be suspended for six months if you receive traffic violations totaling six or more points.

Regular Driver's License

If you are at least 17 years old and have held a beginner's permit for 180 days, you are eligible for a regular SC driver's license. The requirements are as follows:

- If you are under 18 years of age and have never been licensed, you must bring your parent or legal guardian with you to sign your application.
- If you are 18 years old or older, you do not need the signature of your parent or legal guardian.
- You must bring your insurance information.
- You must pass the vision and road tests.

Newcomers and Non-Residents

If you come into South Carolina from another state and establish a permanent residence, you must get a South Carolina driver's license, and also a vehicle license if you own a vehicle.

If you have a valid driver's license issued by the state from which you moved, you can use it for up to 90 days. **You may have only one valid driver's license at any time.** To obtain a SC driver's license, you must present your out-of-state driver's license, birth certificate, social security card, proof of residency and insurance information. If your name has changed from what is on your birth certificate, you must provide legal documentation of the change.

Nonresident drivers from other states, such as students and military personnel and their dependents living temporarily in South Carolina, may drive in South Carolina without obtaining a South Carolina driver's license by maintaining home state driver's license and license plates.

United States Citizens with Credentials from Other States

If you are a new resident in South Carolina and you have a valid driver's license from another state, you may obtain a South Carolina driver's license by passing the vision test and surrendering your out-of-state driver's license. If you have lost your out-of-state beginner's permit, driver's license or identification card, you must also complete an affidavit of lost permit or license along with your South Carolina application. If your out-of-state driver's license has expired by nine

months or more, you must also successfully complete the knowledge and road or skills tests. You must also provide the following documents:

1. Birth Certificate or acceptable substitute*
2. Social Security Card or acceptable substitute*
3. Proof of Residency*
4. Insurance Information

(* See Documents You Will Need section of this manual.)

The Licensing Procedure

If you have studied and practiced carefully before attempting the road test, you should have no trouble passing the test.

Contact your local SCDMV office to check the hours for examinations. To ensure you allow enough time for testing, you should try to arrive at least one hour before the office closes. SCDMV offices do not offer road tests for any type of driver license during inclement weather. For example, rainy streets can make maneuvering a vehicle more difficult for new drivers and ice on the roads can be hazardous for all drivers.

When you are ready, you must take a licensed driver with you to the place of examination, since you cannot legally drive alone. SCDMV will not furnish a vehicle for the road test.

These are the basic requirements for passing the test:

- You must see well enough to drive.
- You must be physically and mentally able to drive.
- You must understand the meaning of traffic signs, signals and pavement markings.
- Your vehicle must be in safe operating condition.
- You must know how to drive safely on streets and highways.
- You must show that you respect the rights of other drivers, bicyclists, pedestrians, motorcyclists or others who share the roads.
- Knowledge and/or skill tests may be taken only once a day or at the return time set by the examiner.

Medical Conditions

Should you have a medical condition that could possibly affect your driving ability, SCDMV may require medical reports prior to renewing or issuing a driver's license or permit.

License Expiration

If you are a United States citizen and you visit a SCDMV field office to obtain an original or renewal license, you will receive a ten-year license unless you are over 65 years of age or under 17 years of age. Persons who are 65 years of age or older or under 17 years of age will be issued a five year license. If you apply for a renewal license online, you will be issued a five-year license.

United States Citizens

If you have a driver's license issued for a period of five years, your license is good until your birthday five years from the year it was issued. If you have a ten-year license, your license is good until your birthday ten years from the year in which your license was issued. If your birthday passes and you have not renewed your license within nine months of the expiration dates, you will be required to take the knowledge and road tests again.

If it has not expired and you have not had more than five points assessed against your driving record during the preceding two years, you will be required to take only the vision test. But if you have had more than five points charged against your driving record for traffic violations in the preceding two years, you will have to take the vision test and the knowledge test.

Military Personnel

South Carolina licensed military personnel must maintain a valid license at all times. When stationed outside the state, you may renew a noncommercial license one time by mail by first obtaining proper forms from the SCDMV before the expiration date of your license. You will have to take the knowledge and road tests if your license has expired nine months or more.

Non-United States Citizens

The expiration date of your driver's license will be determined by your authorized period of stay in the United States or the expiration dates of your employment authorization document. If your license expiration date passes and you have not renewed your license within nine months, you will have to take the knowledge and road tests again.

Documents You Will Need

To get a beginner's permit, driver's license or identification card, you must provide proper identification. The documents you will need will vary based on whether or not you are a United States citizen. Documents will not be accepted if there is evidence that they have been altered. Photocopies of documents are not accepted.

For the most up-to-date information about SCDMV requirements, please visit our website at www.scdmvonline.com or call SCDMV at (803) 896-5000.

United States Citizens

If you are a United States citizen applying for a first time beginner's permit, driver's license or identification card, you must provide original documents showing proof of your U.S. citizenship, identity, social security number, SC residency and insurance information. The documents SCDMV accepts as proof are as follows:

- **Proof of U.S. Citizenship/Identity, Name and Date of Birth**
 - Birth certificate with birth/file number and registrar's signature issued by the county or Bureau of Vital Statistics
 - Birth certificate from U.S. territory (must be translated if not in English) which includes Puerto Rico, Guam, U.S. Virgin Islands, U.S. Samoa
 - Delayed Birth Certificate (If a birth certificate was not issued at the time of birth, the applicant can apply for a birth certificate from the Bureau of Vital Statistics)
 - U.S. Passport (current or expired not more than ten years)
 - Current U.S. Passport Card
 - Original Certificate of Naturalization USCIS form (N-550 or N-570)
 - U.S. government issued Consular Report of Birth Abroad
 - Certificate of United States Citizenship (N-560 or N-561)

If your original your birth certificate shows that you were not born in the United States, you must also provide an additional document from the above list. If the birth certificate is not in English, it must be translated. If your name has changed and the new name is not reflected on your identification document, you must also provide court documents, such as your marriage certificate or adoption records indicating your legal name change.

- **Proof of Social Security Number**

The name on your social security card or substitute document must match the name on your identity documents. The document you present must contain your social security number.

- Original Social Security Card
- Social Security Form SSA-1099, Survivor Benefit Form
- United States Military Photo Identification Card (active, retired or reservist military status DOD, ID, DD-214)
- Current military dependent ID card
- US Uniform Services Identification and Privilege Card (DD1173) that contains a photograph
- Letter from Social Security Administration (requires online verification)
- Medicare letter from the Social Security Administration (requires online verification)
- Medicare Card (requires online verification)
- Payroll stub with employer's name and applicant's name
- W-2 form with employer's name and address and applicant's name

- **Proof of South Carolina Residency**

To prove you are a resident of South Carolina, you must provide documentation that contains both your name and physical address. The following documents will be accepted:

- School Records must be from a SC school and for the current or prior school year.
 - Student ID
 - Report card
 - Letter or contract from Home Schooling Association
 - Official letter from individual's school or school district on school or district letterhead
 - Certified Transcript
 - Diploma from SC school (child has graduated within the last school year)
 - Out-of-state or in-state tuition bill with applicant's SC physical address
- Current Employment records (no more than 90 days old)
Records must be from a SC employer or have a SC address for the applicant on records from an out of state employer.
 - Letter on employer letterhead
 - Pay stub showing SC withholdings
 - Intent to hire on employer letterhead

- Current utility bill (no more than 90 days old)
A utility bill is a bill specific to services for your residence. Examples include electric, water, sewer and cable. Satellite and cell phone bills are not acceptable.
- SC Welfare/Social Services Card
- SC Medicaid cards
- Parolee Cards or letter from parole officer (no more than 90 days old)
- Home mortgage documents (no more than 90 days old)
- Current S.C. Weapons Permit
- County tax notice or property receipt for home or vehicle
- State or Federal Tax records
 - Income tax returns for current or prior year are acceptable including electronic tax file or W2.
 - If applicant is listed as a dependent on SC tax return presented as proof of residency, proof applies to the dependent also.
- Current Military Orders detailing active duty assignment in SC
- Current letter from Military Base with the Commander verifying duty station in SC
- SC Bank statement or a signed letter (must be on bank letterhead) showing name of applicant and SC physical address (no more than 90 days old)
- Original social security check showing name and SC physical address of applicant (no more than 90 days old)
- Insurance documentation (no more than 90 days old)
 - Letter from insurance company or agent licensed to do business in South Carolina stating the name of the applicant and indicating the SC address of the applicant
 - Insurance policy written by the insurance company or agent licensed to do business in SC, showing name of applicant and SC address
- Letter from director of a social welfare institution (homeless shelter, battered women's shelter, halfway house, group home, orphanage, etc.) stating applicant is a resident of the facility (no more than 90 days old)
- Vehicle Insurance Card (only if the SC address and applicant's name appear on card)
- Article of mail with official Post Office address change label



- **Insurance Information**

Before a license can be issued or renewed, you must provide current insurance information. You must provide the company name, policy number and telephone number of your automobile insurance company. If you or any relative in your household does not own a vehicle, you must indicate that fact on your application.

Applicants Under 18 Years of Age

If you are under 18 years of age, you must have a parent or legal guardian sign your application to accept responsibility for you. If you are an emancipated minor, you must submit proof of emancipation with a court order, marriage certificate or active military orders. Only an original document or a certified copy will be accepted.

Applicants from Other Countries

All persons authorized by the U.S. Department of Justice, the U.S. Immigration and Naturalization Service, or the U.S. Department of State to live, work or study in the United States on a temporary or permanent basis will be eligible to apply for a beginner's permit, driver's license or identification card. The expiration date of your driver's license will be determined by your authorized period of stay in the United States or the expiration date of your employment authorization document.

Applications for beginner's permits, driver's licenses and identification cards for international customers are accepted at designated SCDMV offices throughout the state. To find the office location nearest you that accepts international customer applications, see our website at www.scdmvonline.com.

If you are an international customer, you must provide the following to apply for a South Carolina credential:

- Proof of identity
- Proof of birthplace
- Proof of residency
- Social Security Card or Letter from the Social Security Administration stating that the applicant is not allowed to work in the United States
- Automobile insurance information (if applying for a license)

All applicants must provide proper documentation to prove that the US Department of Justice, US Department of State or the US Citizenship and Immigration Services authorizes them to live, work or study in the United States on a temporary or permanent basis, and that they are within their current authorized period of stay. For the most up-

to-date information for SCDMV requirements, please visit our website at www.scdmvonline.com or call SCDMV at (803) 896-5000.

If you are applying for a driver's license, you must also submit a valid driver's license from your country of origin as proof of prior driving experience. If your out-of-country license has expired for more than nine months, you will have to take the knowledge and skills tests. The driver's license information must be translated into English or be accompanied by an International Driving Permit. If you cannot show proof of prior driving experience, you must first obtain a beginner's permit and hold it for 180 days before applying for a driver's license.

To renew or replace your South Carolina credential, you must submit documentation to prove your lawful status. Drivers from other countries may obtain a South Carolina driver's license without taking a test other than the vision test if South Carolina has reciprocity with their home country. Reciprocity can only provide proof of previous driving experience. Canada has reciprocity with South Carolina for both commercial and noncommercial vehicles. The following countries have reciprocity with South Carolina for noncommercial vehicles: France, Germany, American Samoa, Guam, Puerto Rico and the Virgin Islands, the Federated States of Micronesia, the Republic of the Marshall Islands and the Republic of Palau for regular driver licenses only. Mexico has reciprocity only for commercial vehicles with a CDLIS connection.

Applicants from countries without reciprocity must take the complete test. Drivers will be allowed to keep the out-of-country license but the use of the out-of-country license may result in the South Carolina license being revoked. If the out-of-country license has expired, the applicant must successfully complete the vision, knowledge, and skills tests.

Change of Address or Name

Once you have obtained your driver's license or identification card, you will want to make certain that it is kept current. SCDMV must always be notified within 10 days of any name or address changes. There are a number of reasons SCDMV may need to contact you, including matters that affect your driver's license or registration. The fact that you did not change your address and did not receive a letter will not be a valid excuse for noncompliance with requirements. You may change your address at your local field office or at www.scdmvonline.com.

To change your name, you must visit a DMV office and present proper documentation such as a marriage certificate, divorce decree or court order. You cannot change your name by mail or online.

Destroyed or Lost License

If you lose your license or it is destroyed or becomes illegible, you may get a replacement for a fee at your local SCDMV office or by visiting the SCDMV Web site at www.scdmvonline.com. Here are some things you can do to protect yourself in case your license is lost or stolen:

1. Make a record of your driver's license number and your car registration number, and keep those records in a safe place away from your wallet or wherever you keep your license and other papers. A copy of these documents could prove quite valuable should your license be lost.
2. A stolen license should be reported to the local police. However, no action is taken by SCDMV when the driver's license is reported stolen unless we have reason to suspect fraudulent use of this license. Additional documentation, which can be found in the "Documents You Will Need" section of this manual, may be required to obtain a replacement license.



If your license is lost, destroyed or damaged so that it can not be read, you must get a replacement at your local field office or online at www.scdmvonline.com.

Motor Voter Law

If you are a United States citizens and 18 years of age or older, you may register to vote when you have a driver's license issued or renewed. Your registration application will be forwarded to the registrar in your county of residence. You must present acceptable proof of your social security number.

Fraudulent Documents

Anyone who obtains a beginner's permit, driver's license or an identification card using fraudulent information will be prosecuted and the documents they were issued will be canceled.





General Information

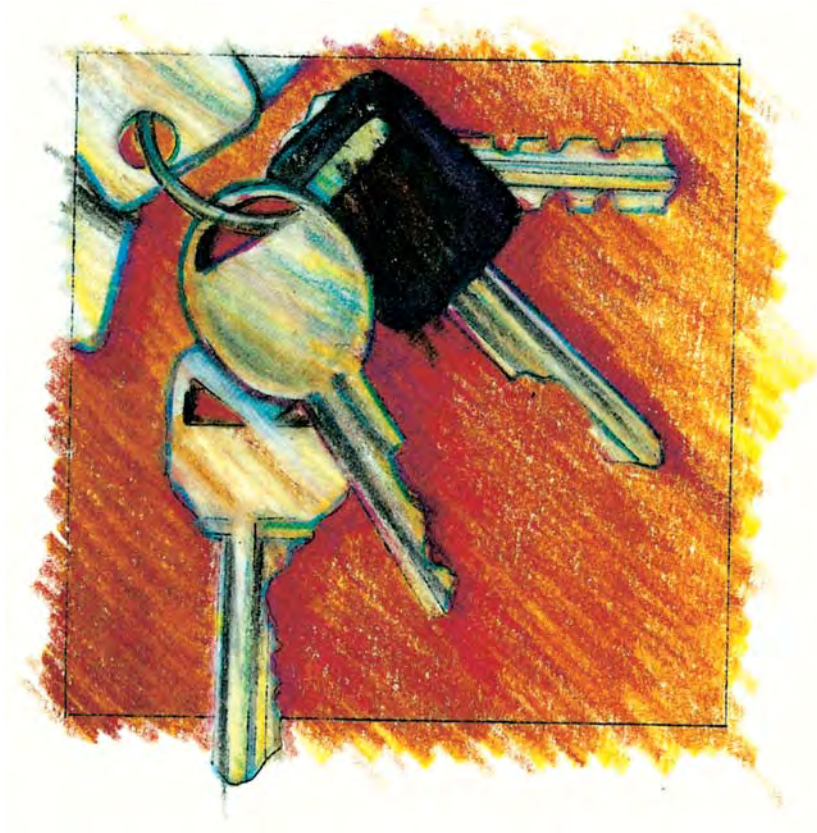

Traffic Safety Rules

Traffic laws that have been passed by the South Carolina General Assembly have but one basic reason for being on our law books. Each one insures the safety of persons on or near streets and highways.

This handbook does not cover all these laws, but it does cover the important ones for you to know in order to drive safely and to guard the lives of persons who share the roads with you.

The state motor vehicle laws are not reproduced in their entirety and the wording is not identical.

Speed

The laws covering speed top the list of things you must know if you are to be a safe driver. The speed at which you are traveling affects almost everything else that can happen to you in a car. Speed, along with an error in judgment, mechanical failure of your car or some traffic violation, is almost always present in fatal accidents.

South Carolina law sets absolute top speed limits at which you may travel on a given road, street, highway or freeway. This does not mean that you have the right to travel at that top speed under any and all conditions.

The law continues to say that no matter what the posted speed limit, you must never drive at a speed faster than is safe for conditions. Fog, rain, snow, ice and other factors that might change the condition of the road or the distance you can see ahead of you are the sorts of things you must consider when you determine a safe speed. Heavy traffic entering from a side road would also require a slower speed.

Speed Limits

Drivers must comply with the posted speed limits throughout South Carolina.

There can be no safe limit set for the entire length of any highway. Curves, hills, intersections and so forth make it necessary to slow down to a safe speed. Towns and cities have many more situations that require you to slow down--schools and pedestrian crosswalks, for example.

The maximum un-posted speed limit in an urban district or residential area is 30 miles per hour. The maximum un-posted speed limit in a rural area is 55 miles per hour except when a higher limit is allowed by the federal law.

Stop At Grade Crossings

You must stop at a railroad crossing when directed by a “flagman” or stop sign, flashing red signals or other devices that warn you of a coming train. Sometimes flashing red signals and gates are present. It is against the law to go around lowered railroad gates at a crossing. Not all railroad crossings are equipped with such warning devices. Some railroad crossings have a yield sign to remind drivers to yield the right of way to any trains that are on the track.

You must approach all crossings with extreme caution and cross only when you know that no train is coming from either direction. Standard railroad crossbucks are found at every railroad crossing.

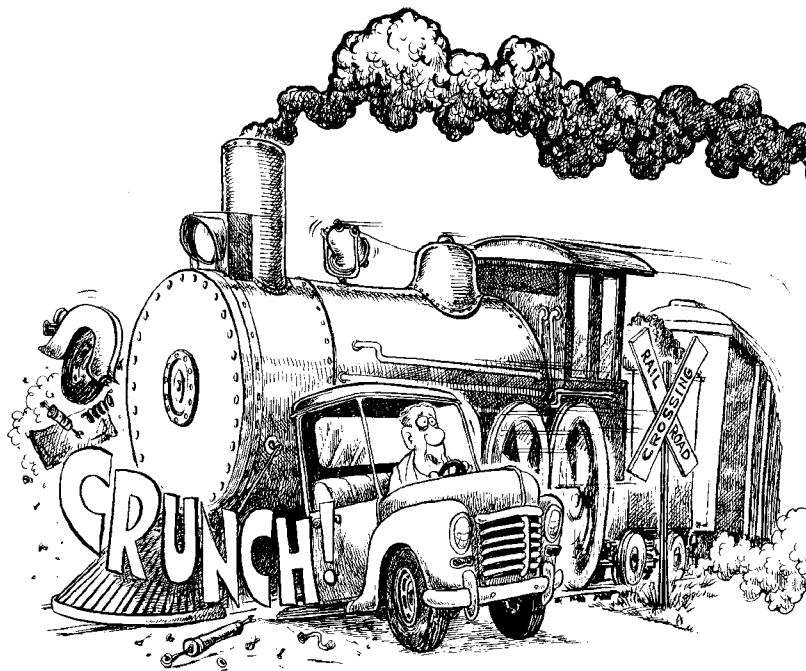

Approach all crossings with extreme caution. Check both directions before crossing.

Stopped School Bus

You must stop for a stopped school bus with flashing lights that is loading or unloading passengers. This is required by law whether you are meeting the bus or traveling behind it under the following conditions:

1. On any two-lane highway.
2. On any four-lane or multi-lane highway only when traveling behind a school bus.
3. When passing a school bus that has red or amber signals flashing.

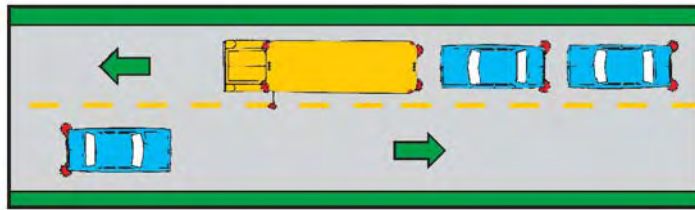

Drivers are required to stop for a stopped school bus when driving on a two-lane road.



You must stop for a stopped school bus with flashing lights that is loading or unloading passengers.

You Do Not Have To Stop:

1. When the bus is in a passenger loading zone completely off the main travel lanes and when pedestrians are not allowed to cross the roadway.
2. A driver of a vehicle need not stop upon meeting a stopped school bus when traveling in the opposite direction on a multi-lane highway or multi-lane private road. A multi-lane highway or multi-lane private road is defined as a highway or private road that consists of four lanes, having at least two traffic lanes in each direction.

You must always stop on any highway when you are behind the bus. When you have stopped, you must not proceed until the bus moves or the driver signals to you that the way is clear, or the red lights are no longer flashing.

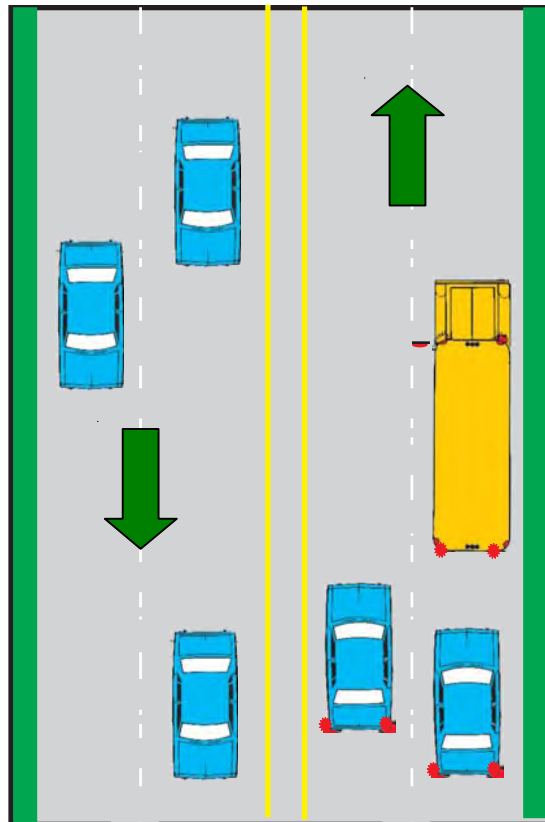

When on a four-lane or multi-lane highway, traffic behind a stopped bus is required to stop. Traffic on the other side of the highway does not have to stop, but should slow down and pass with caution.



Parking And Leaving a Vehicle

Improperly parked vehicles cause accidents. Observe these practices in parking:

1. Never double park. It is both illegal and discourteous, regardless of whether the vehicle is occupied or not.
2. Turn off the ignition and remove the keys from your vehicle when you park and leave it unattended. A good driver always sets the parking brake.
3. Follow all parking regulations. Usually you will find the regulations posted on city streets. Parking time limits vary, so check the time where you are parked.
4. Always park within 18 inches from the curb. Parking away from the curb can cause a serious traffic problem. It is also illegal.
5. On a rural highway make certain that your vehicle is completely off the traveled portion of the highway.

Before you leave your vehicle, always check for traffic behind. Many persons have been killed by opening their car door, getting out, then having an approaching vehicle pin them against the open door. When possible, get out on the curb side.

Places You Should Not Park

It is illegal for you to stop or park your vehicle at any of the following places--except to avoid an accident or unless directed by the law enforcement officer or traffic control device to do so.

1. On an interstate. In case of mechanical trouble or other emergency, stop on the right shoulder, entirely clear of moving traffic.
2. On a sidewalk.
3. In front of a driveway or near enough to hinder the driveway use by others.
4. Within an intersection.
5. Within 15 feet of a fire hydrant.
6. On a pedestrian crosswalk.
7. Within 20 feet of a crosswalk at an intersection.
8. Within 30 feet of a signal light, stop sign or flashing beacon on the side of the roadway.
9. Between a safety zone and the opposite curb.
10. Within 50 feet of a railroad crossing.
11. Within 20 feet of the driveway entrance to any fire station, or within 75 feet of the curb section opposite a fire station entrance.

12. Alongside or opposite any street repair construction area, or other obstruction, where you would hinder traffic.
13. On any bridge, elevated roadway, or in any tunnel or underpass.
14. Along a curb if it is painted yellow or some other color as a “no parking” warning.
15. On a hill or curve, or on the open highway, unless there is clear vision along the highway for a distance of 200 feet in each direction.
16. Where there is a “no parking” sign.
17. Within 500 feet of a fire vehicle stopped in answer to a fire alarm.

Entering And Starting A Parked Vehicle

Before entering your car, look around for any obstacles that might interfere with safe driving. Walk around your vehicle; perhaps you will need to move a child’s tricycle sitting behind your car. Perhaps a child is standing or playing near your vehicle. You would certainly want to be sure he is out of danger.

When getting into your car, make certain the seat is adjusted properly for your comfort and safety. Sit directly behind the steering wheel and make certain that your feet are in a position to operate the foot controls. Adjust your mirrors.

Always fasten your safety belt and shoulder harness if you have one. Make sure they are both firm and comfortable to you. The head restraint on newer cars is an important safety addition. It should be in a correct position so that in the event someone runs into your vehicle from the rear your chances of a neck injury are cut down considerably. Good posture when driving not only makes you a better driver, it also makes you less tired than bad posture.

After starting your vehicle, look again to make certain the way is clear so that you can leave your parked position safely. Look back (do not depend on a rearview mirror), give the proper signal, and back or drive cautiously into the stream of traffic.

The Faster You Go

There is no true table that can be given in this book that will tell you exactly how long it will take you to stop your car or truck when you are traveling at a certain speed.

Many elements enter into the distance it will take, including: your own reaction, weather and road conditions, the weight of your vehicle, the type and condition of its brakes and the condition and type of tires (whether radial, steel belted, snow or studded and the amount of tread, etc.).

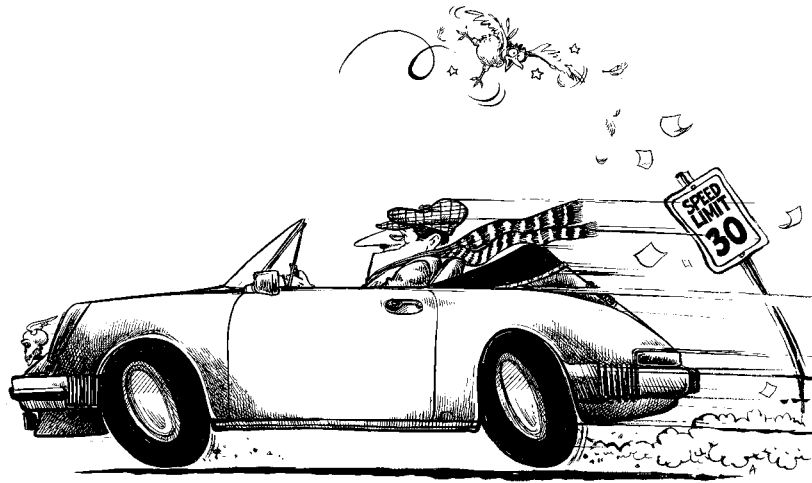

The Killing Speed

Speed can kill. As speed increases, the chance of a fatality increases. If you are going more than 80 miles an hour, you have almost no chance of living through a crash.

The U.S. Department of Transportation has found that the probability of a fatality in a crash roughly doubles as traveling speeds increase from 45 to 60 miles per hour and doubles again as the speed increases from 60 to 70 miles per hour.

Driving Too Slowly

While driving too fast is very dangerous, driving too slowly on certain highways can also be dangerous. You must never drive so slowly that you will interfere with other cars or trucks that are moving at a normal speed.

Many accidents are caused by persons driving too slowly. This causes traffic to “back up” behind them. Motorists in these “backed up” cars become impatient and are tempted to take dangerous chances while passing, in order to get around the slow-moving vehicle. This is why South Carolina has minimum speed laws as well as maximum speed laws.

If you have mechanical problems and traffic begins to pile up behind you, pull over to the side of the road and let the traffic pass. Then, when the traffic has passed, continue on the road, but leave it as soon as possible.

Always try to maintain the speed of the traffic stream in which you are driving, provided it is a speed within the legal limit. Vehicles that cannot meet the minimum speed limit are not allowed on the highways. The only exceptions are farm machinery and construction equipment that is being moved a short distance and has no other way to get to its destination. This type of equipment is not allowed on the interstate under any circumstances.

Traffic Signs, Signals And Pavement Markings

Traffic signs, signals and pavement markings are properly called traffic-control devices because they are engineered to control the flow of traffic. Properly controlled traffic not only moves more efficiently, but also moves in such a way as to make the streets and highways safe for both motorists and pedestrians. Always look for pavement markings and stay within their boundaries. For example, when a marking at an intersection tells you it is a pedestrian crosswalk, stay behind the line and leave the entire allotted space for pedestrian use.

Traffic signs are sometimes referred to as the “signs of life” and that is just what they are. The same can be said for traffic signals and pavement markings.

It is essential that you learn what each means before you can become a licensed driver. You must obey the instructions of official traffic control devices unless directed otherwise by a police officer.



Carefully observe and obey signals of officers directing traffic. Orders from these officers override traffic signals and signs

Obey Traffic Officers

Always closely observe and obey the signal of any officer directing traffic. This is most important during times of traffic congestion or emergency, or at a large public gathering when traffic is heavy and needs special regulation. Orders from a traffic officer must be obeyed even if they are contrary to signs or traffic signals.

While driving a vehicle in a funeral procession, motorists are required to obey all traffic signs and signals unless otherwise directed to proceed by a law enforcement officer within the intersection.

Emergency Vehicles and Scenes

If an emergency vehicle with flashing lights is traveling in the area where you are driving, you must make every effort to give them an open path to travel. If it is safe to do so, pull your vehicle to the side of the road to give them a clear pathway. Do not stop in the road and prevent them from passing your vehicle.

When you approach a scene where there are emergency vehicles, such as law enforcement vehicles, ambulances or fire department vehicles, with lights flashing, you must maintain control of your vehicle. If possible, you should move to another lane of the road that is not close to the scene. If changing lanes is not possible or safe, you should maintain a safe speed for the conditions. Emergency personnel have the authority to direct traffic and you should comply with their instructions.

It is important to exercise caution to ensure the safety of emergency personnel and those they are aiding. If you fail to drive with caution or if you interfere with the performance of their duties, you may be charged with a misdemeanor and required to pay a fine.

Driving At Night

Your driving speed needs to be lower at night than it is in the daytime because the distance you can see is limited by your headlight beams.

Don't overdrive your headlights. You should drive at a speed that will allow you to come to a complete stop, if necessary, within the distance shown by your headlights.

After dark, driving requires different skills and extra care for safe travel. There are certain things to do:

1. When you meet a car at night, you must dim your headlights at

- least 500 feet from the approaching vehicle.
2. When you are following another vehicle at night, you must dim your lights when you are as near as 200 feet to the vehicle ahead.
 3. You should drive with your dim lights (low beam) when you are driving on a well lighted street and on heavily traveled ones.
 4. You should not look directly into the lights of the cars you are meeting. Instead, look toward the right edge of the road.
 5. You should slow down when faced with the glare from approaching headlights. You should never wear sunglasses while driving at night.
 6. You should never turn on your “bright” lights to “pay back” a motorist who is meeting you who fails to dim his lights. This practice doubles the danger for you. Instead, look toward the right edge of the road so that you will not be completely blinded. Of course, you must slow down considerably in such an event.
 7. You should be on the lookout continuously for pedestrians, bicyclists and animals along the roadside.

You must have your headlights turned on at night and from a half hour after sunset to a half hour before sunrise, and at any other time when you have to use your windshield wipers. For example, in rain, sleet, or snow, or when other environmental factors like fog reduce your ability to clearly see people or vehicles on the street or highway at a distance of 500 feet ahead. However, you are not required to use your headlights when using windshield wipers intermittently in misting rain, sleet, or snow.

If your vehicle is parked on a street or highway with the lights on, these lights must be low beam. However, parking lights are best used for this purpose.

Every driver must see that headlights are adjusted so that the low beams are not aimed into the eyes of approaching drivers, and that the windshield and headlights are kept clean.

What To Do In Case of an Accident

No matter how well you follow the safe driving rules, there is always a possibility that you will become involved in a traffic accident. And you need to know what to do. Here are some rules to remember if you are involved in a traffic accident:

1. S.C. law requires you to stop your vehicle if it has not already been stopped by the accident. thelaw also require that you move your vehicle from the roadway to the shoulder after a collision.

This is to ensure your safety and to prevent traffic congestion, which can cause more collisions.

2. Aid the injured.
3. Protect the accident scene as much as possible. If you have flares, flashing lights or a flashlight, use any of these to warn others that there has been an accident.
4. Notify the police, sheriff or the nearest Highway Patrol office as soon as possible, regardless of who is at fault in the accident. Remain at the scene and send someone to notify police.
5. Identify yourself to the other driver by giving your name, address, driver's license number and vehicle license number. Exchange your insurance company name and policy number using your insurance card or proof that the vehicle is insured.
6. The investigating officer will issue a form (insurance verification) to be completed by your liability insurance company verifying that insurance coverage was on the vehicle at the time of the accident.
7. Submit to SCDMV appropriate verification of liability insurance coverage at the time of the accident.
8. Report the accident to your insurance company.



In the event of an accident, notify law enforcement as soon as possible, regardless of who is at fault in the accident.

The driver or owner of each vehicle involved in an accident in which there is apparent property damage or injury or death is required to submit verification that the vehicle was properly covered by liability insurance at the time of the accident. The driver must have a representative of the liability insurance company providing this coverage to properly complete the appropriate form. This insurance

verification must be completed regardless of whether you were at fault or not. This completed form must be returned to SCDMV within 15 days of the issuance date.

How To Avoid Accidents

The secret to avoiding traffic accidents is defensive driving. That is, always be on the lookout for the other driver's errors and don't let his errors cause you to have an accident.

People who make their living driving are told to keep this in mind: "The most dangerous mile is the mile directly ahead of you." If they pay attention and avoid all driving errors in that one mile, they are then ready to take on the next mile and so forth.

1. The first rule in defensive driving is to expect the unexpected from drivers and pedestrians around you. Be prepared to slow down when you are approaching an intersection and you have the green light, or the right of way. Glance at traffic coming in all directions. Is it slowing down to stop or preparing to turn? If you see a driver who appears to be making no effort to stop, then prepare to stop yourself. It's better to give him the right of way than to have an accident.
2. Pay attention to your driving.
3. If you have stopped for a red light and the light turns green, make certain that the traffic from the other street has already stopped and that all traffic is out of the intersection before you start through.

If you are a defensive driver, your eyes are constantly moving while you are behind the wheel – glancing from side to side. You look for possible accident situations and prepare to prevent the accident from occurring. An alley, a plant exit, a driveway into a business and streets with parked cars are only four places where you should be on guard for a person or vehicle to dart into your path. Anticipating the actions of others is the key to defensive driving. Assume the other motorists will do the unexpected.

Driving Emergencies

Emergencies happen. Whether they are serious or minor, there are things you can do to help. Following are the most common emergencies that can happen to you on the road--and how you can handle the situation carefully and safely.

Brake Failure

This is perhaps the most frightening emergency you can have when you are driving. It's very dangerous, but you can do the following to avoid a serious emergency:

1. Pump your brakes.
2. Apply the emergency parking brake carefully.
3. Shift to low gear.
4. Blow your horn to let others know that you are in trouble.
5. Rub a curb or sideswipe an object rather than hit something head on, if necessary to avoid a more serious accident.

Flat Tire

A flat tire is probably the most common occurrence and is more of an inconvenience than anything else. It is important, however, to know how to handle your vehicle when a tire goes flat:

1. Hold the steering wheel firmly to maintain steering control.
2. Touch the brakes lightly; never "slam" on your brakes, since it is important to come to a stop gradually, in full control of your vehicle.
3. Pull off the roadway as soon as it is safe to do so.

Stuck Accelerator

There's a feeling of panic when the accelerator of your vehicle sticks and you begin traveling much faster than you would like. The important thing to remember is this: Don't panic and slam on the brakes. This could cause you to have a collision with another car or run off the road.

Follow these basic steps:

1. Shift to neutral. Your vehicle will then begin to slow down on its own.
2. Apply the brakes after shifting to neutral.
3. Turn off the engine when it is safe to do so. (If you have power steering and power brakes, shutting off the engine will make these two extremely important car functions difficult to manage. The steering wheel may lock if engine is turned off.)
4. Pull off to the side of the road just as soon as it is possible to do so safely.

Stalled on Tracks

If your vehicle stalls on a railroad track and a train is approaching, don't try last-minute heroics to move it. Get all passengers and yourself out as fast as possible. Run in the general direction of the approaching train, but away from the tracks.

Emergency Stop

When you must make an emergency stop along a road or highway, switch on the four-way flashers if your vehicle has these safety devices. Park your vehicle completely off the traveled portion of the highway and use any method you can devise to let others traveling the road know you're there (flares, flashlights, etc.).

Raise the hood and tie a piece of cloth to a left door handle. Get out of your vehicle on the right side, if possible, and stand clear of traffic until help comes.



Move a disabled car safely off the roadway and tie a handkerchief or other flag on the car to signal for help.

When Wheels Run Off the Pavement

If one or more of your wheels runs off the pavement, don't panic. Grip the steering wheel firmly. Begin to slow down. Do this by taking your foot off the accelerator. Do not attempt to cut back sharply onto the pavement. Look to see that the road is clear, then move slowly back onto the highway.

An Oncoming Vehicle In Your Lane

A vehicle approaching in your lane presents an especially critical emergency on freeways, where speeds are faster and less time is available for decision making. You should sound your horn and pull as far to the right as possible. The traffic safety experts agree that even driving into a ditch would be less hazardous than a head-on collision.

Avoid Skidding

Hard braking is sometimes required, but a driver should be warned not to slam on the brakes, which could result in skidding into another vehicle or loss of vehicle control.

Turning curves or corners too fast will cause skidding. Worn tire treads and poor brakes with unequal gripping can result in a skid. Other causes are water puddles, where dirt has washed onto the road surface, loose sand, wet leaves or gravel.

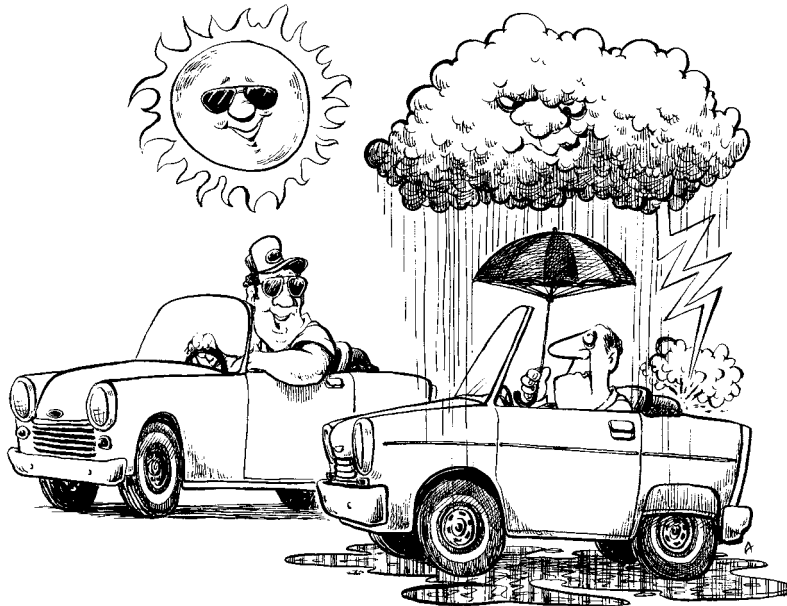

Changes in the weather call for changes in driving. Be careful at all times.

Weather Changes Call For Safe Driving

38

A sudden change in the weather calls for a change in driving.

Posted speed limits are for ideal weather only. Slow down in rain and fog. Your low-beam headlights (not parking lights) will help others to see you even if they don't help you see much better. In fog, slow down and use your low beams. Be particularly aware of vehicles that may be coming up behind you and driving too fast. Tap your brakes lightly to make the driver aware of your vehicle.

In rainy weather there is the problem of skidding. A light rain can make driving more dangerous than a downpour. The oil film and rubber particles left on the road surface by vehicles as they travel blend with the rain to form a moisture that can be extremely slick.

If you drive too fast on wet roads you may start "hydroplaning"--that is, moving over the surface of the water without even touching the

road surface. As you go along under these circumstances, you have no control over your vehicle, especially if you have a little or no tread on your tires. Even under the best conditions, hydroplaning can occur on wet pavement.

Heavy rain washes away most oil and rubber accumulations, but wet pavement, in general, is where most skidding occurs.

Winter Driving Techniques

South Carolina generally does not have extreme winters but occasionally gets some snow and ice. If you must drive, use tire chains or special snow tires on your vehicle. Also, you should:

1. Keep your windshield and windows clear.
2. Test road conditions carefully. Applying the brakes gently is best for slowing down or stopping.
3. Allow additional distance between your vehicle and others when there is snow or ice. (Ice patches may occur on bridges when there is no ice on the roads.)
4. Approach intersections with caution.
5. Generally avoid hills, but if necessary, drive slowly and keep a steady pace and a good interval between you and the vehicle ahead. If you stop on a hill, it's extremely difficult, if not impossible, to get going again.
6. When possible, travel in the tracks where other vehicles have gone before.
7. When you get stuck in snow, try using cardboard, newspaper or brush under your wheels for traction.
8. Load extra weight into the trunk of your car. This will help give your car traction (rearwheel drive). Keep a full tank of gasoline to prevent condensation which may freeze in your tank causing further problems.
9. Do not abandon your vehicle in the roadway, if at all possible.

Experts say that letting a little air out of your tires may help give you added traction, but it can also prove dangerous. Since most of today's tires are tubeless, if too much air is released, the seal will be broken around the rim of the tire, resulting in a flat tire.

Driving In Fog

When driving in fog you should slow down and use your low-beam lights. If the fog is so bad that you cannot see, pull off the road and wait for the fog to clear.

Driving In Smoke

If you notice that the road ahead is covered by heavy smoke, reduce your speed immediately, drive as far as possible to the right and stop off the roadway. Then determine if it is safe to continue.

Certain types of smoke, if inhaled, can irritate your lungs and eyes. Inhaling smoke from chemical fires can kill you.

If you suddenly enter smoke and it is very thick, slow down, turn on your low-beam headlights, signal for a right turn and get off the traveled portion of the roadway as quickly as you can. Then turn on your emergency flashers.

After you have stopped, get yourself and all passengers out of the vehicle and move back in the direction from which you were traveling to get out of the smoke and to warn other drivers of the situation.

If possible, notify the Highway Patrol or law enforcement agency. Never stop on a highly traveled portion of the freeway or roadway. This could cause an accident for other drivers.

Flooded Roads

Flooding can occur when rivers and streams overflow their banks, when dams or levees break, when there is run-off from deep snow or any time there is heavy rainfall. Floodwaters can be found on roads, bridges and low areas. Flash floods can come rapidly and unexpectedly. They can occur within a few minutes or hours of excessive rainfall.

- Do not drive through flooded areas. If you see a flooded roadway ahead, turn around and find another route to get to your destination.
- Be cautious, **especially at night**, when the visibility is limited.
- Remember, six inches of water will reach the bottom of most passenger cars, causing loss of control or possible stalling.
- Two feet of moving water can carry away most vehicles, including sport utility vehicles and pick-up trucks.
- Even if the water appears shallow enough to cross, do not attempt to cross a flooded road. Water can hide dips and other unseen hazards. Floodwaters can also damage roadways by washing away the underlying road surface.
- If there is no other route, proceed to higher ground and wait for the water to subside.



Know Your Vehicle

Driving a car or a truck in unsafe mechanical condition is both dangerous and illegal in South Carolina. You cannot be given the road test part of the examination unless the vehicle in which you expect to take the test meets all the requirements of state law. If the examiner finds your vehicle to be defective, you must have it corrected before being tested. The driver is responsible for having the vehicle in safe driving condition.

Brakes

Your vehicle must have two separate means of applying brakes--a foot brake and a parking brake. The foot brakes must be able to stop your vehicle within a braking distance of 24 feet when traveling at 20

miles an hour on a dry, smooth, level road. The parking brakes must be able to hold your vehicle on any hill.

There are additional brake equipment requirements for trailers, semitrailers, etc., which you should learn if you intend to drive this type of vehicle.

Horn

Your vehicle must have a horn that can be heard 200 feet (nearly a half block) away, but you should not have a horn or other warning device that would give off unreasonably loud and harsh signals. Remember, the horn should be used as a warning when necessary for safety.

Exhaust System

Your car must be equipped with a muffler and exhaust pipe in good condition so that they will reduce noise and prevent poisonous gases (carbon monoxide) from escaping into the vehicle--especially when the windows are closed. A faulty exhaust system can result in carbon monoxide poisoning, which can be fatal to those traveling in a car or truck or sitting with the motor running. If you become drowsy while driving you should open a window for fresh air. You should stop your vehicle and check to determine if your exhaust system is leaking.

Mirrors

Your vehicle must have an inside rearview mirror. For safety's sake, an outside mirror is considered a "must" by careful drivers. Even with these mirrors, which should be used constantly when a driver is in traffic, there remains a blind spot. If a vehicle is built or loaded so that a regular inside mirror does not allow the driver to see behind him, then he must obtain a special type of outside mirror and have it located so the he can see what's happening in the traffic behind him. The left, outside mirror should be adjusted to let you see just a little of the left side of your vehicle when you are sitting in a normal driving position.

Windshield

Windshield wipers should always be in good working order. Your car or truck must never have any sign, poster, or other sticker upon the windshield or windows that might interfere with the driver's view.

All window glass must be in good condition so as not to interfere with the driver's vision.

Tires

The tires on your vehicle must have good treads and otherwise be in safe condition. It is important to remember that high speed, especially in hot weather, places added stress and strain on tires and could cause

an already weak tire to give way and result in an accident.

Have your tires checked at least once every week for proper air pressure and condition, including punctures, breaks and tread wear. Good tread can be a lifesaver, particularly when driving on wet pavement, because it can prevent your car or truck from going into a dangerous skid.

License Plate

Your vehicle must be officially registered and the single license plate must be displayed on the rear of your vehicle, except for truck tractors and road tractors used for towing trailers. The license plate must be visible at night by means of a white light illuminating it. You have a responsibility to make certain your license plate can be read.

Lights

You should make sure that all lights on your vehicle are working at all times.

Illegal Equipment

The following are illegal “extras” for any vehicle in South Carolina:

1. A red light in front. Only authorized emergency vehicles such as fire engines, ambulances, etc., may have these warning signals.
2. A siren, bell or whistle.
3. A muffler “cutout,” or loud sounding muffler.
4. Signs, posters or stickers on the windshield or windows unless required or permitted by law.
5. More than one spotlight installed.
6. More than two fog lights.
7. More than two side or fender lights.
8. More than two backup lights. These must not light up when the vehicle is going forward.
9. Any load (on your passenger car) extending beyond the fender on the left side or six inches beyond the fender on the right side.
10. A blue light, which is for law enforcement officers only.
11. A television in the front seat where it can be seen by the driver.

For your safety and the safety of others, make sure that your vehicle has all the required equipment in good working order at all times.

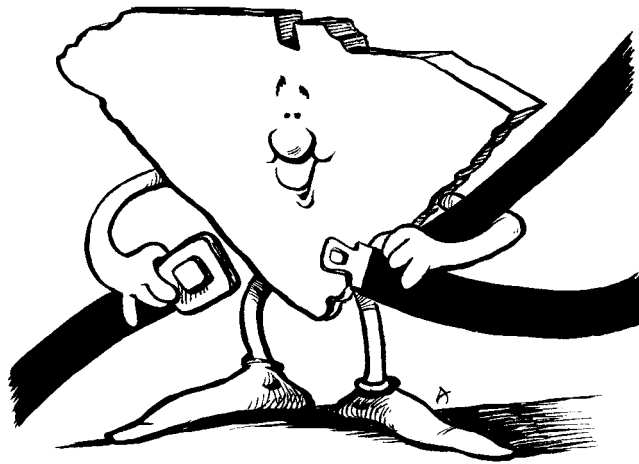

Buckle up! It's the law!

Safety Belts Save Lives

Safety belts save lives. No one who works in traffic safety doubts this for a moment. Yet drivers and passengers continue to ignore this lifesaving feature. Safety belts sit idle while traffic fatalities continue to mount.

Develop the safety belt habit. Before long it will become something you do automatically. The same goes for the shoulder harness in your vehicle. The federal government requires manufacturers to equip all vehicles with safety belts and shoulder harnesses. A light on the dash will flash or a buzzer will sound to remind you to buckle your safety belts. Use your safety belt and shoulder harness, whether you're driving just around the corner or taking a trip to California--or anywhere in between.

If your car or truck does not have safety belts, do yourself a favor and have them installed immediately. Safety belt use is required by law.

Child Restraint

Child restraint seats approved by the National Highway Traffic Safety Administration are required for children under six years of age. Children under 6 years of age may not sit in the front passenger seat. However, this restriction does not apply if the vehicle has no rear passenger seats or if all other rear passenger seats are occupied by children less than 6 years old. This law does not apply to church, school and daycare buses, taxis, or commercial vehicles.

Four out of five children in safety seats are improperly restrained.

Parents should have their children's safety seats inspected for proper installation. The Department of Public Safety, Office of Highway Safety, maintains child passenger safety seat fitting stations. For more information, call (803) 896-9950 or 1-877-349-7187. You can also visit their Web site at www.buckleupsc.com.

FOUR STEPS FOR PROTECTING CHILDREN IN CARSEATS	
Step 1	Children from birth to 1 year old, or who weigh less than 20 pounds, must be secured in a rear-facing child safety seat.
Step 2	Children 1 through 5 years old weighing 20 to 40 pounds must be restrained in a forward-facing child seat.
Step 3	Children 1 through 5 years old weighing 40 to 80 pounds must be secured in a belt-positioning booster seat.
Step 4	Children under the age of 6 are not required to be in booster seats if they weigh more than 80 pounds or if they can sit with their backs against the car's seat and bend their legs over the seat edge without slouching.

Sharing the Road

When you're behind the wheel, you're sharing the road with many other drivers, pedestrians, and cyclists--just to name a few. Taking the appropriate precautions can mean the difference between life and death.

Sharing the Road with Pedestrians

Pedestrians are key participants in our transportation system. A trip taken by foot requires no gas, creates no emissions, reduces traffic congestion and even improves the individual's health. Just as they share the road with other cars, it is important for motorists to stay alert to the presence of pedestrians. Every mode of travel has equal priority on the road, and it is the motorist's responsibility to yield to a pedestrian.

Any person on foot, such as a runner, walker or a mother with a stroller, is a pedestrian. A pedestrian can also be someone who uses roller skates and skateboards or a person with a disability on a tricycle, quadricycle or in a wheelchair.

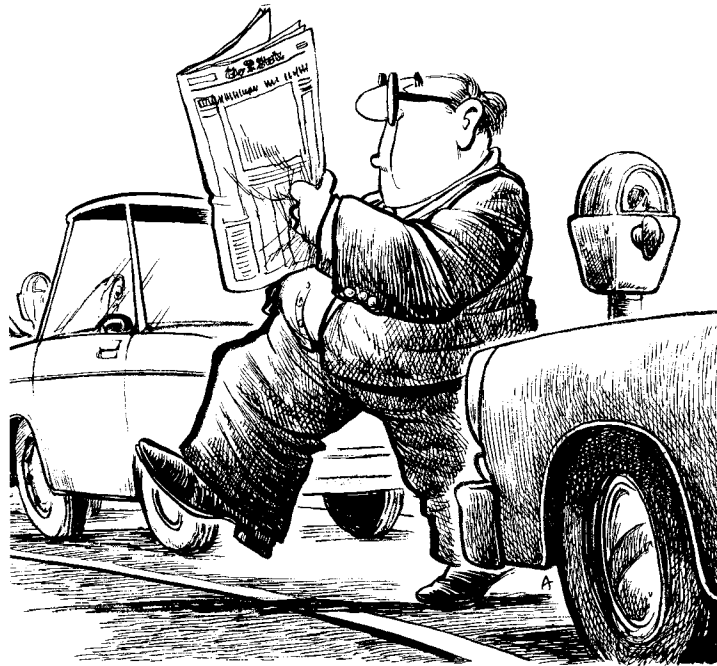

It is your responsibility to take precautions not to injure a person on foot.

As a driver, it is your responsibility to be on the lookout and to take every precaution possible not to injure a person on foot. If you see a vehicle, pedestrian or children near the road, you should slow down and be prepared to stop.

There are three types of persons who most often become pedestrian fatalities: the small child, the older person and the drinking public.

In the case of very young children, a responsible driver will always check around his car before getting into it to be sure no child is in the vehicle's path.

Walking from behind parked cars is a very common action in fatal accidents involving a pedestrian. All three types of pedestrians that we mentioned commit this dangerous action. A child chasing a ball gives no thought to an oncoming car. His mind is strictly on play, and he may dart into the street quite suddenly. Some older people may not be able to move as quickly as younger persons, and they may have sight or hearing impairments, making it difficult for

them to see a car or to judge its distance. A drinking pedestrian may have his senses and his judgment impaired.

As a responsible driver, you should always slow down and be prepared to stop quickly when you are driving on streets lined with parked cars. You must also react in the same manner when you come upon any situation where people are gathered alongside of the street or highway on which you are traveling.

Night is a particularly dangerous time on rural highways for pedestrians.

Sounding the horn of your car as a warning is always a good idea when you are faced with a vehicle-pedestrian collision. It may warn the person on foot in time for him to stop or move out of the road. The law acts to regulate pedestrians' actions as well as your actions as a motorist. At the crosswalk you should yield by slowing or stopping for a pedestrian who is on your side of the roadway, or who is close enough to your side to be in danger. Unless they are at an intersection or within a marked crosswalk, pedestrians must yield to vehicles. Pedestrians must walk facing traffic.

In entering an intersection on a green signal, a driver making a right or left turn is required by law to yield to pedestrians on the cross street lawfully within the intersection. Do not stop in a crosswalk.

Blind pedestrians have special protection under the law. South Carolina law requires that a driver must stop and yield the right of way to a blind person who has entered a street carrying a white cane or is accompanied by a guide dog.

Whether the pedestrian is handicapped or not, you as a driver should always be willing to give the pedestrian the right of way, regardless of whether he has it or not.

Again, slow down and keep a watchful eye in all areas where pedestrians are located—urban areas, around schools and institutions and street and highway intersections—and all other places where groups may be congregated. Take your responsibility seriously; keep your eyes open for him. After all, every person is a pedestrian at one time or another...and that includes you.



As a driver, it is your responsibility to look out for bicyclists. They have a right to use streets and highways, too.

Sharing the Road with Cyclists

As a driver, you have a responsibility to be on the lookout for cyclists. Treat him courteously, since he does have the same rights and responsibilities as automobile drivers to use the streets and highways. Cyclists are part of the normal traffic flow and are entitled to share the road with other drivers.

A growing problem for drivers is the inability to see the bicyclist. The motorist is very often technically at fault in a bicyclist-motor vehicle collision. The most common reason given is "I just didn't see him." Sometimes he may be in the "blindspot" of your car. You should constantly check the "blindspot" by looking over your shoulder, checking your rearview mirror and by moving your eyes from side to side in anticipation of the bicycle rider.

Cyclists must ride in the same direction as other traffic, not against it. A cyclist may, but is not required to, ride on the shoulder of the roadway. They may ride in a lane other than the right-hand lane if only one lane is available that permits the cyclist to continue on his intended route. They should normally ride in a straight line as near to the right curb or edge of roadway as practical. Cyclists can legally move left to turn left, to pass a parked or moving vehicle, another bicycle, an animal or to make a turn, avoid debris, or other hazards.

A cyclist may indicate a right turn by extending the left arm upward, by raising the left arm to the square, or by extending the right arm horizontally to the right. A left turn is indicated by extending the left arm horizontally. A decrease in speed or stop is indicated by extending the left arm or the right arm downward. A cyclist is not required to give signals if the hand or arm is needed to control the cycle.

A 'bicycle lane' is the portion of the roadway or a paved lane separated from the roadway that has been designed by striping, pavement markings, and signage for the exclusive use of cyclists. When a bicycle lane has been provided adjacent to the roadway, motor vehicles may not block the bicycle lane to oncoming bicycle traffic and shall yield to a cyclist in the bicycle lane before entering or crossing the lane. Cyclists are required to ride in the bicycle lane except when necessary to pass another person riding a bicycle or to avoid an obstruction in the bicycle lane. However, cyclists may ride on the roadway when there is only an adjacent recreational bicycle path available instead of a bicycle lane.

Remember, it is unlawful to harass, taunt or maliciously throw an object at or in the direction of any person riding a bicycle.

Here are some of the critical points for drivers to remember:

1. When attempting to pass a bicyclist, you must treat the bicycle as any other vehicle you would pass.
2. Allow for the bicyclist to make mistakes. Watch for swerving cycles and sudden turns.
3. The horn should be used to attract the bike rider's attention and not as a threat to get out of your way.
4. Drivers must be careful when driving close to cyclists and should maintain a safe operating distance between the motor vehicle and the cyclist.
5. Before passing a cyclist in a narrow traffic lane, wait until the traffic is clear in the opposite lane and then change lanes to pass the cyclist. Do not attempt to squeeze past the cyclist.
6. Leave ample room when turning right after passing a cyclist so the cyclist is not cut off when you slow for the turn.
7. Even with a proper headlight and rear reflector, a bike is still difficult to see. Use extra caution after dark, especially in poorly lighted areas.
8. Automobile drivers should anticipate cyclists at parks, playgrounds, near schools and especially in residential areas. Night is a very difficult time for the bicycle rider and the automobile driver; alertness is required from both.
9. After parking on streets and before getting out of a motor vehicle, the driver and passengers should be careful not to strike a bicyclist when opening car doors.

Sharing the Road with Motorcycles and Mopeds

Motorcycles have the same rights and responsibilities as other drivers on the road. However, it is more difficult to see them. There are special situations and conditions drivers need to be aware of so we can safely share the road with them.

- Motorcycle operators have the right to use a complete traffic lane and two motorcycles may share a lane. A car should not try to share a lane with a motorcycle.
- A motorcycle's size can easily move into a car's blind spot. Always make a visual check for motorcycles by checking all mirrors and blind spots before entering or leaving a lane of traffic and at intersections.
- Never assume a motorcycle is turning when you see a turn signal flashing. Motorcycle turn signals may not turn off automatically. Do not pull out in front of a motorcycle unless you tell they are turning.
- Signal your intentions before changing lanes or merging with traffic to allow the motorcyclist time to anticipate traffic flow.
- Obstacles and road conditions can sometimes be easily maneuvered around by a motorist, however, can be deadly to a motorcyclist. Be prepared for sudden changes in lanes or speed as they avoid road hazards. Allow room for the motorcyclists to maneuver.
- Follow the same rules for a moped as listed above.

Sharing the Road with Emergency Vehicles

Emergency vehicle drivers must drive with regard for the safety of other highway users. Under emergency conditions drivers may violate certain rules of the road such as driving faster than the posted speed limit, going through a red light or stop sign after slowing down, parking in places where it is usually prohibited, and disregarding rules covering direction of movement or turning.

Some emergency vehicles have sirens and flashing red lights or a combination of flashing red and blue lights. These lights help the emergency vehicles move quickly through traffic to assist emergency calls. The different types of emergency vehicles include ambulances, fire department and police cars.

As a driver when you hear a siren or an emergency vehicle approaching you should pull over to the curb or the edge of a road and stop. For one way streets drive parallel to the road edge closest to you. Avoid intersections when possible. After the emergency vehicle passes, check the traffic around you before you return to the roadway. You must keep a safe distance between your vehicle and the emergency vehicle. During an emergency situation you must obey any uniformed officer.



SHEP vehicles assist stranded motorists and provide emergency traffic control during incidents. You may contact SHEP by dialing *HP.

Sharing the Road with Commercial Vehicles

There are many crashes between cars and commercial vehicles each year. To actively prevent these crashes from occurring a driver must remember large vehicles:

- Do not maneuver like a car. It takes longer to stop and accelerate a large vehicle and they need more room to turn.
- Have much larger blind spots than cars even though a truck driver sits higher above the road than a person driving a car.

The No-Zone is areas around large trucks and buses where cars cannot be seen. These blind spots are found on the sides, rear and front of a large vehicle.

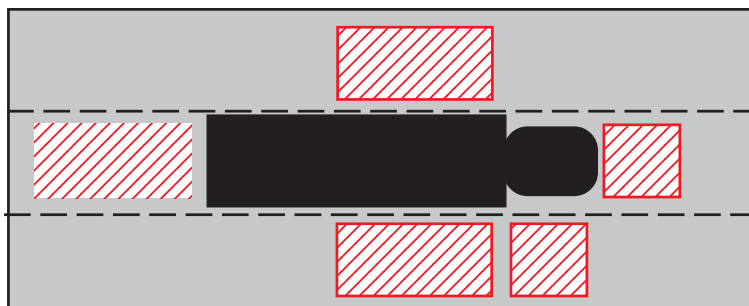

Avoid lingering in the "NO ZONE" indicated by the red striped areas.

- **Side No-Zones** – The Side No-Zones are located on both sides of large trucks and buses. Trucks have a larger blind spot on the right side starting behind the cab and extending the length of the truck. If you cannot see the driver's face in the side mirror, they cannot see you. Always avoid driving beside a large vehicle for long periods at a time.
- **Front No-Zones** – Due to the size and weight of trucks and buses they take longer to stop than cars. Therefore it is essential to not enter a roadway or change lanes in front a large vehicle. When changing lanes make sure you can see the entire front of the vehicle in your rear-view mirror before pulling in front a large vehicle. It is important to maintain the same speed while doing this.
- **Rear No-Zones** – Blind spots for large vehicles can extend up to 200 feet directly behind the vehicle. The large vehicle cannot see your car and you cannot see traffic directly in front of you. Avoid following a large vehicle too closely and position yourself so that the driver can see you easily. When possible, avoid driving in the right lane when traveling up and down hills and when approaching truck weigh stations where large vehicles will be re-entering faster moving traffic.
- **Turning** - Truck drivers must make wide turns in order for the rear of the truck can clear corners and curbs. It is very important to pay close attention when a large vehicle uses turn signals. Do not pass a truck until it has completed turning as sometimes it uses space from other lanes to clear corners.

Be Cautious Around Work Zones

A work zone is any type of road work which may delay traffic conditions. Work zones usually involve lane closures or detours. Sweepers, line painting trucks, mowing equipment and heavy machinery are common moving equipment in work zones.

Work zones on highways have become increasingly dangerous for workers and drivers. When approaching a work zone watch for materials such as cones, barrels, signs, large vehicles, or workers to warn you and direct you where to go. All temporary signs in work zones have an orange background and black letters or symbols. These signs can be found on either side of the road and tell you what and how soon you will encounter a work zone.

Most work zones will notify the driver of any speed limit changes. Speed reductions are intended for the safety of workers and motorists. Reduced speed limits are clearly posted within the work zone and if there are no reduced signs, drivers should obey the normal speed limit.

Keep the following tips in mind while entering a work zone:

- Slow down and obey posted speed limits.
- Follow work zone sign instructions and those given by a flagger.

- Remember work zones can change daily, including lane shifts and closures.
- Be extremely cautious in a work zone at night.
- Watch the traffic around you and be prepared to react to what the traffic is doing. Be ready to respond quickly if necessary.
- Keep a safe distance between your vehicle and traffic barriers, trucks, construction equipment and workers. Most importantly, don't tailgate.

Police and Traffic Stops

If you are pulled over by a police officer, pull over to the right side of the roadway and stop your vehicle as far away from traffic as possible to ensure safety for both you and the police officer.

Turn off the engine, radio, CD player or any other device which may get in the way of communication with the officer. If it is nighttime turn on your hazard flashers and interior lights to help the officer see. Roll down your window to communicate with the officer.

It is important that you and your passengers remain calm and keep your safety belt fastened. Keep your hands on the steering wheel and limit movements. If the officer asks for your driver's license, proof of insurance and/or vehicle registration tell the officer where it is located and slowly reach for them. Remain in the vehicle at all times unless requested by the officer to get out. Always answer questions clearly and fully.

Never run from the police as it is dangerous. Many fatal crashes occur from police chases. The consequences for running from the police are more severe than the initial traffic violation.

Littering Is Against The Law

One of the most thoughtless and distasteful things you can do while riding in a vehicle is to throw trash along the streets and highways. It's also against the law. Offenders can be arrested and fined. You can be fined for litter law violations and directed to pick up litter along the roadsides under supervision of the court.

Take pride in your state and its beauty. Don't be included in that group of thoughtless and irresponsible people who litter the highway.

You should keep a litter container in your car or truck at all times. Place paper cups, candy wrappers, bottles and other litter in this container. Then, when the container is filled, dispose of it in a trash can or other appropriate litter receptacle. Cigarettes and cigarette butts are also considered litter and should be kept inside your vehicle until they can be disposed of properly.

Driving Tips For Mature Drivers

These are the problems that face an older driver in today's traffic:

- A. As age progresses, hearing and eyesight are often less keen.
- B. Judgment may be slower. It takes longer to recognize traffic situations and to make the necessary decisions.
- C. Physical dexterity is weakened. Older people may not have the same ability to act with speed and decisiveness in an emergency.
- D. The older driver may forget that the volume of traffic is increasing all the time and that new rules and regulations are being continually introduced.

Here's a chance to check your own driving. These are common causes of trouble among older drivers. If two or three of the points apply to you, you should take the necessary steps to correct them.

1. Do you need two or three tries when parking your car parallel to the curb in a parking space?
2. Have you encountered difficulty in distinguishing between objects, such as a hydrant and a small child, when driving at night?
3. Does the glare from headlights of approaching cars cause prolonged discomfort to your eyes at night?
4. Do you have trouble maintaining the pace of other cars or do they seem to be passing you all the time?
5. Does it take you quite a long time to get going again after the light has turned green?
6. Are you getting an increasing number of minor scrapes (such as from your garage door) and dents on your car?
7. Are you missing STOP signs, highway signs and other traffic indicators?
8. Do you find yourself becoming confused when unexpected or unfamiliar things happen while you are driving?
9. Do you have trouble making out objects that are a few feet away?
10. When a car is approaching you on the road, do you have trouble judging how far away it is at a given moment?
11. When you are looking straight ahead in the driver's seat, do you have difficulty seeing the sides of the road?

Drugs and Driving

Drugs are everywhere and in every form. Some are prescribed by physicians while others are purchased over the drugstore counter. There are medicines for colds, fatigue, tension, depression and many other conditions that make human beings uncomfortable. Many of the drugs we take carry warnings for adverse side effect such as dizziness, drowsiness or sleepiness. If you are taking medications, be aware of the side effects and do not drive if they interfere with your ability to drive.

Certain illegal drugs, which may do you serious harm under any circumstances, present an especially serious hazard when you drive a vehicle after using them.

Driving requires your full attention. You need to be at your best physically, mentally and emotionally. Medications, both nonprescription and prescription, can be extremely dangerous if you are suffering side effects and are therefore less alert and less in control of your reflexes than you would be under normal circumstances.

Perhaps the most dangerous aspect of drugs and driving is when medicines (drugs) are used in combination with alcohol or other drugs. The effect may make you unfit to drive. If you take medications for such conditions as nervousness, obesity, high blood pressure, hay fever and asthma, and then take only one ounce of alcohol, the mixture can become many times more dangerous.

Keep all of these things in mind when you're getting ready to drive. Don't endanger your own life and the lives of others by driving when you are not up to par.

Alcohol is the Most Abused Drug in America

There's no doubt about it: alcohol is the most abused drug in America today. Drinking plus driving equals deaths in many cases. South Carolina traffic records show that drinking is definitely involved in a high percentage of all fatal accidents. There are so many incorrect ideas about alcohol and what it does that there is not enough room for us to go into all of them in this book. But we will mention three wrong notions:

1. "Drinking alcohol increases efficiency." This is not true. Alcohol is not a stimulant. It's a depressant, so it relaxes. Alcohol hits you first in two places: in the brain (dulling your judgment) and in your reflexes (making them unreliable).
2. "If you've had too much to drink, coffee, milk or food will sober you." This is also untrue. Only time will sober you. Alcohol leaves the body at the rate of about one ounce per hour. Once the alcohol is in your body, there is nothing you can do to hurry that process.

3. "If you stick to beer or wine, you won't get drunk." Untrue. It's the alcohol that causes the problem, not the form in which you take it: liquor, beer or wine.

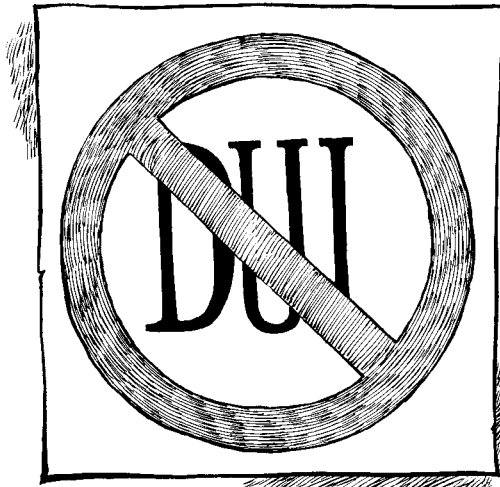

If you drink...don't drive.

SC has an implied consent law. This law says that by driving on the state's streets and highways, a motorist implies his consent to take a chemical test for intoxication. If you refuse to take this test when called upon to do so, your license immediately will be suspended for six months. This will be in addition to any suspension you might receive if you are convicted for driving under the influence of intoxicating liquors or unlawful blood/breath alcohol content.

This same law says that if the chemical test shows you to have a blood alcohol concentration of 0.08 percent or higher, it may be inferred that you are under the influence of alcohol. It doesn't take many drinks to reach this level.

If you are under 21 years of age and drive with a blood/breath alcohol content (BAC) of .02 or greater, you will be suspended for three months for the first offense and six months for a second offense within a five year period. If you refuse to take the chemical test to determine the alcohol content in your blood, you will be immediately suspended for six months for the first offense.

That old saying, "If you drink, don't drive," is still true. If you are going somewhere and plan to drink, make plans to have someone along who will be sober, and let him or her drive. If there's no one who can assume the driving responsibility, then call a taxi or catch a bus. Don't drive. If you are driving and have an accident, your troubles are multiplied and could very easily change the rest of your life.

Keeping Your License

Your driver's license grants you the privilege of driving a motor vehicle on South Carolina's streets and highways. You may also enjoy, with your South Carolina driver's license, the privilege of operating a motor vehicle in every state of the United States.

This privilege lasts only as long as you drive safely. That's why this handbook constantly reminds you about safe driving. Nothing is more important. Remember, as a driver, safety is your most important job.

If your license is withdrawn: This means that there is some condition that has come to the attention of SCDMV which says you are not qualified to have a driver's license. You will not be able to get one again until the reason for the withdrawal is corrected.

Withdrawal results from the mandatory requirement of law following conviction on certain traffic violations.

If your license is revoked: You must wait until the period of revocation is passed, make a new application and take the complete examination just as if you never had a license. You should check to determine the financial responsibility requirement.

If your license is suspended: You cannot drive again until the time has passed for your suspension under the point system; for driving under the influence; or for two charges of reckless driving, and so forth. You must take both the knowledge and road tests for reinstatement of your driving privilege. You should check to determine the financial responsibility requirements also.

If your license is cancelled: This indicates that you never should have had a valid license in the first place, except where a signature of responsibility for a minor is withdrawn. It could come about because of falsification of information on your license application or concealing facts which could affect your driving privilege.

If your license is revoked, suspended or cancelled, SCDMV will mail you a letter. For certain offenses, you must surrender your license to the court at the time of conviction. If you do so, your suspension period may begin on the date of the conviction unless you are already suspended for another reason. If you do not surrender your license to the court, you must either bring or send it to SCDMV.

License Revocation

Your license will be revoked when:

1. You are found guilty of killing any person while driving a car in a careless manner.
2. You are found guilty of any felony in which a motor vehicle is used.
3. You are involved in any accident in which someone is killed or

- injured and you fail to stop and give assistance.
4. You are convicted of driving a motor vehicle engaged in a race on a public street or highway.
 5. You furnish false information pertaining to financial responsibility on your motor vehicle registration.
 6. You become mentally or physically incompetent to drive.

License Suspension

Your license will be suspended when:

1. You are found guilty, or forfeit bond, on a charge of driving while under the influence of intoxicating liquor or narcotic drugs. For the first conviction your license will be suspended for six months, for the second offense one year, for the third offense two years. This is in addition to the fines that may be imposed.
2. You refuse to take the test for intoxication when called upon to do so by a law enforcement officer. If the officer has complied with all the requirements of the law in this instance, then your refusal to take the test can mean that your driving privileges will be suspended for six months. This is in addition to any suspension if you are convicted of driving under the influence of intoxicating liquor.
3. You are convicted of reckless driving for a second time within five years and each subsequent conviction within that period. The law provides severe penalties for those found guilty of reckless driving. You are driving recklessly when you willfully drive any car or other motor vehicle in a manner that disregards the lives and property of others. Your driver's license will be suspended for three months if you are convicted (or forfeit bond) on a second charge.
4. You are involved in an accident and subsequently sued for damages and an unsatisfied judgment is rendered against you.
5. You help another person to race on a public highway by lending him a motor vehicle, or if you "soup up" an engine for the purpose of racing either for yourself or someone else. The penalties for this violation of the racing law are severe:
 - (a) If you are convicted of taking part in a race on any public road, street or highway, you may be fined or imprisoned or both. In addition, your driver's license and vehicle registration will be suspended for one year.
 - (b) If you assist in a race, or permit your vehicle to be used in a race, you may be fined and/or imprisoned. In addition, your driver's license and your vehicle registration will be suspended for three months.
6. You are convicted of hauling illegal whiskey.
7. You accumulate 12 points under the point system law which includes violations committed outside of the state.

8. If you hold a beginner’s permit, conditional provisional or special restricted driver’s license and you accumulate six or more points, your driving privileges will be suspended for six months for Excessive Points. If you are suspended for Excessive Points, completing the National Safety Defensive Driver Course, or it’s equivalent, will not reinstate the suspension. The points that resulted in the Excessive Points suspension can also be used in a Point System suspension.

If you are a violation-prone driver but will recognize your faults and so improve your driving so that you get no more points, your record will eventually be cleared. Points one year old are cut in half, and after two years they will be wiped out completely. The violation, however, will remain on your record for three years from the date SCDMV received the ticket. A provision in the law provides for reducing a driver’s points by four upon successful completion of an approved defensive driving course. Only one such reduction in a three-year period is permitted under this provision.

The following are violations and the points for each:

Hit and Run, property damage only.....	6
Reckless driving.....	6
Passing stopped school bus.....	6
Speeding 25 mph or more above posted limit.....	6
Disobedience of any official traffic device.....	4
Disobedience to official directing traffic.....	4
Disregard railroad sign or signal.....	4
Disobedience to signal of approaching train.....	4
Driving on wrong side of road.....	4
Driving through or within safety zone.....	4
Failure to give or giving improper signal.....	4
Failure to yield right of way.....	4
Following too closely.....	4
Operating with improper brakes.....	4
Passing unlawfully.....	4
Speeding more than 10 mph, but less than 25 mph.....	4
Driving too fast for conditions, over 10 mph.....	4
Turning unlawfully.....	4
Defective tail light.....	2
Driving a vehicle in unsafe condition.....	2
Driving in improper lane.....	2
Failure to dim lights.....	2
Improper backing.....	2
Improper dangerous parking.....	2
Operating with improper lights.....	2



Shifting lanes improperly.....	2
Speeding 10 mph or less.....	2
Driving too fast for conditions, 10 mph or less.....	2

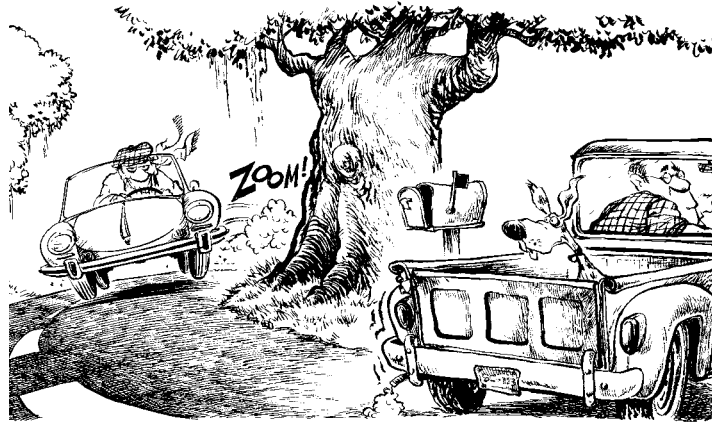

Reckless driving that disregards the lives and property of others is punishable by law.

License Cancellation

Your license can be cancelled:

1. If you are a minor (under 18 years old) and your parent or guardian or whoever signed for you withdraws his or her signature from your license application
2. If you give false information on your application.
3. If you are male and decline Selective Service at age 18.

Driving Under Suspension

Of course, if your license has been revoked, suspended or cancelled you must not drive a vehicle until the condition which brought about such an action is cleared. If you do and are apprehended and convicted, you will be fined and/or imprisoned and your suspension will be doubled. For a second conviction, there is a fine and/or imprisonment and the suspension time will again be doubled. For a third and subsequent offense you may be subject to imprisonment and your license suspension will be doubled.

Driving Without a License

The penalty for driving without a licence includes a fine and/or imprisonment.

Alcohol and Controlled Substance

South Carolina law requires the suspension of driving privileges if you are under 21 years of age and are convicted of possession of alcohol (beer, wine or liquor), even if the violation did not occur in a motor vehicle. A person over 21 can also have their driving privileges suspended if they are convicted of transferring alcohol to a minor.

For a first offense, in addition to a fine and/or imprisonment, your driver's license will be suspended for 120 days and for a second or subsequent offense, your driver's license will be suspended for one year. If you are convicted of a controlled substance violation, your driving privileges will be suspended for six months for hashish and marijuana and one year for any other controlled substance in addition to fines and/or imprisonment.

Delinquent Child Support

Your driver's license will be suspended if you are in arrears in child support payments. Once suspended, the Department must receive verification from the Department of Social Services before your privilege to drive can be restored. You may be eligible for a route restricted driver's license.

Habitual Offenders

A habitual offender driver law is in effect in South Carolina. Its aim is to remove from the highways those drivers whose driving records show they are a danger to others.

The law provides that a driver will be classified as a habitual offender if he is convicted of having committed, within a three year period:

- Three of more major offenses, or
- Any combination of ten minor offenses or moving violations for which four or more points are assigned under the point system.

A driver who has been classified a habitual offender will have his or her driver's license suspended for five years.

- Major Offenses
 - Child Endangerment
 - Driving Under Suspension
 - Driving Under the Influence
 - Failure to stop for blue light resulting in Bodily Injury or Death
 - Felony Driving Under the Influence
 - Felony in a Motor Vehicle
 - Leaving the Scene of an Accident with Bodily Injury or Death
 - Passing a Stopped School Bus with Bodily Injury or Death

- Reckless Driving
- Reckless Homicide
- Unlawful Alcohol Concentration
- Voluntary or Involuntary Manslaughter
- Subsequent Offenses of: Failure to Stop for a Blue Light
- Minor Offenses
 - Disobeying an Official Traffic Device
 - Disobeying an Official Directing Traffic
 - Driving on the Wrong Side of the Road
 - Driving through or within a Safety Zone
 - Driving Too Fast for Conditions - over 10 MPH
 - Failure to Give or Giving Improper Signal
 - Failure to Yield Right of Way
 - Following Too Closely
 - Hit and Run Property Damage
 - Operating a Vehicle with Improper Brakes
 - Passing a Stopped School Bus
 - Passing Unlawfully
 - Reckless Driving
 - Speeding Over 10 MPH
 - Turning Unlawfully

Accident-Prone Drivers

Any licensed driver who is involved as a driver in four reportable accidents in any 24-month period, according to law, may be required to take any portion of the driver's license examination or the license may be recalled by the SCDMV. Failure to do so will result in suspension of the driver's license until he or she takes and passes the required test.

Provisional Driver's License

A South Carolina licensed driver who is convicted of a first offense driving under the influence of intoxicants or unlawful alcohol concentration may qualify for a "Provisional Driver's License." The initial steps to obtain such a license are:

1. File proof of financial responsibility for the future with SCDMV..
2. Enroll in an Alcohol and Drug Safety Action Program (ADSAP) approved by the South Carolina Department of Alcohol and Other Drug Abuse Services. The commission maintains offices and conducts the school in each county of the state. Consult your local telephone directory for the South Carolina Department of Alcohol and Other Drug Abuse Services for further information. The provisional driver's license is issued for a period not to exceed six months. After the suspension period, a person must successfully complete all phases of the driver's examination, pay

a reinstatement fee, maintain SR-22 and have completed ADSAP prior to being issued a regular driver's license.

To obtain the provisional driver's license, the individual can have no other existing suspension recorded against him. This license will be automatically revoked and the full suspension imposed if the person is charged with and convicted of any violations totaling four or more points or any other law relative to the operation of a motor vehicle for which suspension of a driver's license is made mandatory by law.

Drivers whose licenses have been suspended due to driving under the influence of alcohol or drugs are required by law to enroll and successfully complete ADSAP and file an SR-22 insurance form.

Route-Restricted Driver's License

A route-restricted driver's license is only available for certain suspensions and not all drivers are eligible. This type of special license allows a SC driver to drive to and from work, college, ADSAP classes and any court ordered program while he or she is under suspension. Drivers under the age of 21 who have been charged with registering an alcohol concentration of .02 or greater or refusing to submit to a breath, blood or urine test are not eligible for a route-restricted license.

Temporary Alcohol License

A temporary alcohol license is available to eligible drivers while they await the outcome of an administrative hearing for registering an alcohol concentration of .15 or greater, refusing to submit to a breath, blood or urine test.

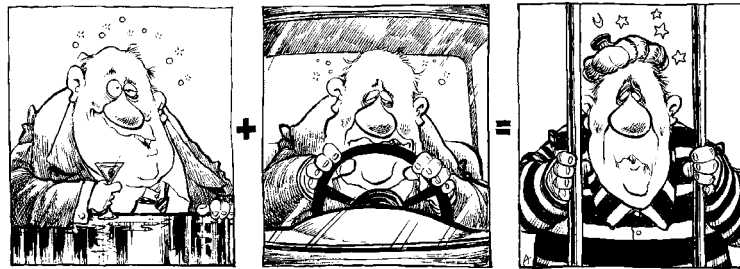

Drinking plus driving equals jail. Don't drink and drive.

Driving Under the Influence

The cost of driving under the influence of intoxicating beverages or drugs can be a lot more than you may imagine.

If you are found guilty or forfeit bond on a charge of driving under the influence of intoxicating liquor, narcotic drugs or unlawful blood/breath alcohol content, your privilege to drive will be suspended. The offenses and corresponding suspension periods are as follows:

First Offense - Six month suspension

Second Offense - One year suspension

Third Offense - Two year suspension

Fourth Offense - Permanent suspension.

If you receive three convictions within five years, your driving privileges will be suspended for four years. Prior violations are determined by violations occurring within a ten year period.

If you are eligible for a provisional license, you will have to pay to attend the required Alcohol and Drug Safety Action Program (ADSAP) school, prove that you have SR-22 liability insurance coverage, and pay the required fee for a provisional license.

Before obtaining a regular license, you must have successfully completed the ADSAP school, pay a reinstatement fee, and maintain SR-22 liability insurance coverage.

If, while driving under the influence, you have an accident in which you cause great bodily injury to someone else, you will be charged with a felony DUI, fined, imprisoned and your driver's license will be suspended for three years plus the term of imprisonment. If death results, you will be fined and your driver's license will be suspended for five years plus the term of imprisonment. Penalties for every DUI offense after the first one are progressively severe. No part of the minimum sentence can be suspended.

License suspension periods also increase with subsequent offenses. Upon the fourth violation, you will be permanently barred from being issued a license to operate a motor vehicle.

The legal drinking age in South Carolina is 21 years of age. If you are under 21 when you obtain your license, it will be marked with "Under 21" to make verification of your age easier. It is illegal to be in the possession of any alcoholic beverage in an open container in a moving vehicle on the highways.

Ignition Interlock Device (IID)

If you have been convicted of a second or subsequent DUI offense, have completed the required license suspension period, and the Alcohol and Drug Safety Action Program (ADSAP), and you wish to get your driver's license back, you must get an IID installed on the vehicle you plan to drive. The length of time you will be required to

have the IID installed will depend upon your convictions and any violations you might have during the program.

For additional information, contact the IID Program Manager at ignition@ppp.state.sc.us or 803-734-9220. You may also visit the South Carolina Department of Probation Parole and Pardon Services Website at www.dppps.sc.gov/ignition_interlock.html.

Vehicle Immobilization

If you are convicted for a second or subsequent offense of Driving Under the Influence (DUI), Driving with Unlawful Alcohol Concentration (DUAC), or Felony Driving Under the Influence (DUI), DMV will issue a thirty day registration suspension on all of the your active vehicle registrations.

Implied Consent Law

South Carolina has an implied consent law. This law states that every motorist implies his consent to take a chemical test for intoxication simply by driving on South Carolina's streets and highways.

Persons Over 21 Years of Age

If you are over 21 years of age and register a Blood/Breath Alcohol Concentration (BAC) of .15 your privilege to drive will be suspended. The offenses and corresponding suspension periods are as follows:

- First Offense – One month suspension
- Second Offense – Two months suspension
- Third Offense – Three months suspension
- Fourth and Subsequent Offense – Four months suspension

If you refuse to take the test for intoxicants and it is your first offense, your privilege to drive will be suspended. The offenses and corresponding suspension periods are as follows:

- First Offense – Six month suspension
- Second Offense – Nine months suspension
- Third Offense – Twelve months suspension
- Fourth and Subsequent Offense – Fifteen months suspension

Persons Under 21 Years of Age

If you are under 21 years of age and register a BAC of .02 or greater, your privilege to drive will be suspended immediately for three months. If you have prior violations of DUI, Felony DUI, Implied Consent or a BAC of .02 or greater in the last five years of the first offense, your driving privilege will immediately be suspended for six months.

If you refuse to take the test for intoxicants and it is your first offense, you will immediately lose your driving privileges for six

months. If you have prior violations of DUI, Felony DUI, Implied Consent or a BAC of .02 or greater in the last five years of the first offense, your driving privilege will immediately be suspended immediately for one year

Insurance and Financial Responsibility

South Carolina's Motor Vehicle Financial Responsibility Law was designed to protect citizens against financially irresponsible drivers who are involved in motor vehicle accidents. South Carolina Law requires every owner of a vehicle that is required to be registered in this state to maintain liability insurance or, if qualified, pay \$550.00 for registering as an uninsured vehicle.

Insurance Requirements

If you choose to insure your vehicle rather than register as an uninsured motor vehicles, you must maintain liability insurance on your vehicle. Liability insurance must remain in effect as long as your car is registered. Your insurance provider must be licensed and authorized to do business in this state. The minimum liability insurance limits in this state are 25/50/25. This limits provide coverage for:

1. Injury or death to one person
2. Injury or death to more than one person
3. Property damage in any one accident
4. Uninsured motorist protection.

Maintaining Proof of Insurance

The owner of a motor vehicle must maintain proof of insurance in his motor vehicle at all times. The vehicle owner must be able to provide this proof upon demand of a law enforcement officer. Anyone who fails to maintain proof of insurance on his motor vehicle is guilty of a misdemeanor and may face suspension action by the SCDMV. If action is taken, the owner's driver license will be suspended and he or she may have to pay a \$100.00 reinstatement fee.

SR-22 Insurance

Some suspensions require SC drivers to file SR-22 insurance before their driving privileges can be restored. SR-22 insurance is proof of financial responsibility for the future. If you are required to file SR-22 insurance and you fail to maintain that coverage, your driving and/or registration privileges will be suspended and you may be required to pay up to \$400 in reinstatement fees.

Operating an Uninsured Vehicle

If a law enforcement officer determines that a vehicle you are operating is uninsured and the vehicle has not been registered as uninsured, you will be guilty of a misdemeanor and may face suspension action by the department. If you are both the owner and the operator of the vehicle, your driving and registration privileges will remain suspended until the \$550 uninsured motorist fee is paid and SR-22 insurance is filed. If you were the driver, but not the owner of the vehicle, your driving privileges will be suspended for 30 days and you will be required to pay a \$100.00 reinstatement fee.

Registering as an Uninsured Motor Vehicle

If you choose to register your vehicle as an uninsured vehicle, the \$550.00 fee is not an insurance premium and you are not purchasing any insurance by paying this fee. This uninsured motorists fee is for the privilege to drive and operate an uninsured motor vehicle on South Carolina's roads. Not all drivers will be eligible to register their vehicle as an uninsured vehicle. Contact your local SCDMV office or download the Uninsured Motorist Registration application (form DMVB-18) from the SCDMV website at www.scdmvonline.com to review the requirements you must meet to register a vehicle as an uninsured motor vehicle.

Self-Insured Vehicles

Some companies or individuals that own at least 26 vehicles may wish to self-insure their vehicles. Anyone wishing to be self-insured must apply with the Financial Responsibility office for approval.

Cancelling Insurance Coverage

It is the responsibility of the vehicle owner to surrender the vehicle license plate(s) and registration certificate(s) to their local SCDMV office if liability insurance is not being maintained on their vehicle. If the liability insurance is cancelled or there is a lapse of coverage for any reason, your driving and vehicle registration privileges may be suspended and you may have to pay reinstatement fees up to \$400.

Verifying Insurance Coverage for an Accident

If you are involved in an accident in South Carolina, you have 15 days to have your insurance company verify insurance coverage on the date of the accident. Failure to do so may result in the suspension of your vehicle registration and driving privileges. Your credentials will remain suspended until you have confirmed that insurance coverage existed at the time of the accident.

If the vehicle was not covered with liability insurance at the time of the accident, you may obtain a notarized release from each party receiving bodily injury or property damage and submit it to the Department of Motor Vehicles. You may also enter into an installment agreement with appropriate parties or deposit acceptable securities in an amount set by the department to satisfy any judgement that may be rendered as a result of the accident.

If the department determines that no liability insurance coverage existed at the time of the accident, you may be required to pay the \$550.00 uninsured motorist fee. You may also be required to file SR-22 certificate of insurance. If your driver's license is suspended, you may be required to pass the knowledge and skills tests before your driving privilege will be reinstated. A reinstatement fee is also required for each driver's license suspension.



Cars: The Road Test

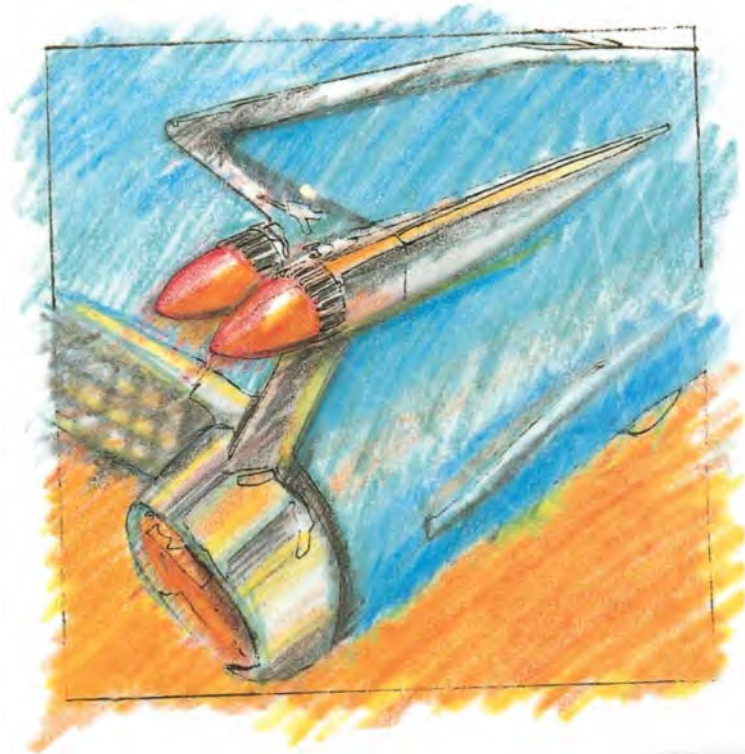

What the Examination Involves

Vision Test

Your eyes will be tested by a mechanical device. If you need glasses, you will be required to wear them while driving. Your license will be coded for corrective lenses.

Knowledge Test

This test consists of a series of questions about your responsibility as a driver, including knowledge of laws and safe driving practices.

You must also know the meaning of standard road signs. To learn more about road signs, please refer to the “Traffic Signs, Signals and Markings” chapter of this book.

Road Test

Of course your car must be in safe driving condition before you can be given the test. The examiner will direct you to make certain starts, stops, turns and maneuvers that will help him determine whether you can handle a vehicle safely.

Parallel Parking

You will see an example of the proper way to parallel park your car or truck. Study this drawing, then practice many times doing what it tells you. Look back before and while backing your car.

Stopping Smoothly

You must be able to stop your car or truck as quickly and smoothly as possible, without stalling the engine. The examiner will be instructing you in this driving maneuver.

Backing

You must back your car for a distance of 100 feet at a slow rate of speed and as straight and smooth as possible. Turn your head and look back before and while backing. Be sure the way is clear of any other traffic. You will be required to pull off the road or turn your wheels full lock left or right before backing.

Stopping at Stop Signs

You must give the proper hand or brake signal, approach the sign in the proper lane, and stop before reaching a stop line or a pedestrian crosswalk. Remain stopped until you may proceed safely.

Turning Around

You must be able to execute a three-point turn on a street of average width, without hitting the curb, driving off the road surface or using a driveway.

Proper Clutching

If your car or truck has manual transmission, you will be asked to show the proper way to use it. You must hold the clutch all the way down when starting the motor and shifting gears. Do not ride with your foot resting on the clutch.

Approaching Corners

You must get in the proper lane, decrease the speed of your vehicle and look in both directions, making certain that the way is clear before entering the intersection.

Yielding the Right of Way

Always yield the right of way to pedestrians, motor vehicles, bicyclists, or anyone else who has moved into an intersection before you.

Stopping on Grades

You will be asked to stop correctly on a hill. If your car has a stick shift, it should be left in first or reverse.

Starting on Grades

Give appropriate signal, look back over your left shoulder, and when the way is clear, pull slowly into the street or highway.

Turning

Get into the proper lane and give a signal for at least 100 feet (about one fourth of an average city block) before reaching the intersection and making the turn.

Passing

Always look ahead and behind you to make certain no other vehicles are so near to you that it would be dangerous to pass. When necessary for warning another vehicle of your intention to pass, sound your horn. Carefully check the traffic. When the way is clear, signal your intent to pass, pull out of your lane to pass and then speed up a little so that you can get around the other car or truck as quickly and safely as possible. However, do not exceed the speed limit.

Railroad Crossings

You may have to demonstrate how to cross railroad tracks during the road test.

Using The Horn

The horn must be used only when necessary to warn pedestrians, motorcyclists, bicyclists, or others who share the road with you. Do not use the horn to signal friends or to hurry other drivers.

Maintaining Good Posture

You will be expected to maintain good posture while taking your road exam. This means having the seat adjusted so that you are able to reach the various foot pedals, as well as the steering wheel, gear shift lever and turn signal lever. Also, you must be able to see without obstruction in all directions at all times.

Steering a Vehicle

Steering

The steering wheel is always turned in the direction you want the vehicle to move, whether moving forward or in reverse. Both hands should be placed on the outside of the steering wheel on opposite sides. Your grip on the steering wheel should be firm but gentle. Use your fingers instead of the palms of your hands and keep your thumbs up along the face of the steering wheel. Never turn the wheel while gripping it from the inside of the rim.

The proper grip on the steering wheel of a vehicle is extremely important. Think of the steering wheel as the face of a clock. Place your left hand at the 7 to 9 o'clock position and your right hand at the 3 to 5 o'clock position. Your grip should be firm but not too tight. Both of your hands should remain on the steering wheel at all times except when one hand is performing some other necessary function of driving such as shifting gears or giving hand signals for turning, slowing or stopping.

It takes practice to get the "feel" of the vehicle you are handling. When you are first learning to handle your car or truck, choose rural roads that are lightly traveled, when possible. After you feel you can steer the car accurately, making the tiny adjustments that are constantly necessary in steering, then you will be ready to practice other driving techniques such as turning and parking.

Hand-to-Hand Steering

Use hand-to-hand steering, commonly called push/pull steering, when turning the wheel during normal driving activity going forward above 10-15 mph. When using hand-to-hand steering your left hand grasps the wheel between 7 and 8 o'clock and your right hand grasps the wheel between 4 and 5 o'clock. Depending on the direction of the turn, your right or left hand pushes the wheel up and the opposite hand slides up, grasps the wheel and pulls down to continue the turn. While the pulling hand moves down, the hand that initially pushed up slides back toward its original position to make adjustments as needed. The driver should use the area on the wheel between 11 and 8 o'clock with the left hand and the area on the wheel between 1 and 8 o'clock with the right hand regardless of the direction of the turn. Simply reverse the hand-to-hand process to bring the vehicle into your intended path.

With your left hand positioned in the area between 7 and 9 o'clock and your right hand positioned in the area between 3 and 5 o'clock there tends to be less muscle stress; therefore, less steering causing any weaving in a lane. With your arms next to your body, it is more natural to keep both of your hands on the wheel at all times. Since your hands and arms never cross over the steering wheel, there is less chance of injury to the face, hands and arms in the event of a frontal crash when a vehicle is equipped with a driver side air bag. This is the preferred method of steering, 2 and 10 o'clock is not recommended because it can be dangerous in vehicles equipped with air bags.



Hand-Over-Hand Steering

Use hand-over-hand steering when turning the wheel at low speeds, such as at an intersection or when parking the vehicle. When using hand-over-hand steering, your left hand grasps the steering wheel between 8 and 9 o'clock and your right hand grasps the wheel between 3 and 4 o'clock. Depending on the direction of the turn, use the right top third of the steering wheel to move the wheel to the right and use the left top third of the wheel to move the wheel to the left. This process is repeated as necessary. Simply reverse the hand-over-hand process to bring the vehicle into your intended path.

Evasive Action Steering

When anti-lock brakes are engaged (if equipped) and steering inputs are required to avoid a hazard or the vehicle is forced off the roadway, it may be necessary to limit the steering input to avoid moving out of the intended lane of travel and across other lanes of travel. This evasive action/limited steering approach has been recommended with dealing with these problem areas since 1969. Vehicles designed after 1969 allow the vehicle to move 12 feet to the left or right at speeds under 35 with a 180 degree steering input to move the front of the vehicle, followed by a 360 degree input to move the back of the vehicle, followed by a 180 degree steering input to return the vehicle to a straight position without losing traction to the tires. As speeds increase much less steering input is needed to move the vehicle one lane space to the left or right. Modern vehicles only take 45 to 90 degrees of steering to move a vehicle back on the road after an off-road encounter. It is critical to limit the steering to not more than 180 degrees of steering when trying to evade a problem on the roadway. When more than 180 degrees of input is used, traction loss occurs and often the vehicle moves across the roadway in the approach of oncoming vehicles.



One Hand Steering

Use one hand steering only when backing or operating vehicle controls (wipers, flashers, lights, etc.) that require a temporary reach from the steering wheel. The placement of one hand on the steering wheel is critical to vehicle balance, steering reversals and avoiding potential injury. When the driver is required to reach for an operating control, it is important to keep the other hand in the normal vehicle operating position of 8-9 o'clock or 3-4 o'clock, depending on the steering wheel design. This keeps vehicle stability, reduces steering reversals and allows for additional steering efforts as needed. The only time that 12 o'clock is recommended is when backing a vehicle to the left or right and the driver has to turn in the seat in order to see the path of travel to the rear.

Manual Transmission

Driving a car with a manual transmission requires coordination of clutch, accelerator, and gearshift lever.

Using the Clutch

The clutch pedal must always be pressed down to the floor before starting the engine, before shifting, and before coming to a stop. Depressing the clutch disconnects the engine from the wheels and takes the car out of gear. At other times when driving, keep your foot off the clutch pedal. The habit of "riding the clutch," driving with the left foot resting lightly on the clutch pedal, causes needless clutch wear.

Shifting should be done smoothly from one position to the next and always with the clutch depressed to the floor. The speeds given for shifting are only intended to be guidelines.

Using Stick-shift Gears

Neutral: Car should be in this gear when starting engine.

First: This gear is used to start the car in motion. First can also be used for driving up or down very steep hills, for driving in mud, snow or ice, and for pulling heavy loads.

Second: This gear is used to bring the car up to a higher speed. It may also be used for steep hills or for driving in snow or ice.

Third: This gear in a three-speed transmission is used for steady forward driving. In a four-speed transmission, third is used to accelerate.

Fourth: This position is used on all level roads.

Fifth: This gear, in some cars, is also a cruising gear for higher speeds on level roads.

Reverse: This gear is used for backing the car. Never shift to reverse when the car is moving.

Starting The Engine

The following procedure is used to start a car with manual transmission:

1. Make sure parking brake is on.
2. Press clutch pedal to the floor with your left foot.
3. Put gearshift lever in neutral.
4. Turn on the ignition switch, and check the bulbs in the warning lights to make sure they work.
5. Turn the key forward only until engine starts.
6. Check gauges.

Putting The Car In Motion

1. With clutch pedal to the floor, move the lever from neutral to first gear.
2. Depress the foot brake and release the parking brake.
3. Signal. Check for traffic in both mirrors.
4. Check traffic ahead and behind by glancing over your left shoulder.
5. If clear, accelerate slightly, and release the clutch slowly. If you release it suddenly, the car will jerk forward and the engine may stall. You will feel the engine take hold and begin to move the car. The point where the engine takes hold is called the friction point.
6. Hold the clutch momentarily at the friction point.
7. Gradually press down on the accelerator, and let the clutch up all the way.

Shifting From First To Second

At about 10 to 15 m.p.h., use the following steps to shift from first to second gear:

1. Press the clutch down.
2. Release the accelerator.
3. Move the gearshift lever into second. A slight pause as you go across neutral into second will help you shift smoothly.
4. Accelerate gently as you release the clutch, hesitating briefly at the friction point.

Stopping From Upper Gears

When stopping from third, fourth or fifth gear, always use the brake pedal first to slow down before pressing down the clutch. By keeping the car in gear, the engine helps slow the car. In an

emergency, applying the brakes without using the clutch at all will stop the car. Follow these steps to stop the upper gears.

1. Check mirrors for traffic.
2. Let up on the accelerator.
3. Tap brake lightly to signal for a stop.
4. Brake gradually.
5. Press clutch pedal down.
6. Brake to a smooth stop. Shift into first or the proper gear when stopped.

Downshifting

Downshifting means shifting from a higher gear to a lower gear. The engine has greater pulling power in lower gears than in higher ones. If you have slowed down to about 15 m.p.h. in a 3-speed transmission and need to regain speed, you must downshift from third to second gear. Depress the clutch and shift to second gear. Accelerate gradually and let the clutch out, pausing briefly at the friction point. Depress the clutch and shift back into third gear when proper speed has been obtained.

You should downshift for added control, as when slowing down before entering a very sharp turn. Downshifting can also be used for extra pulling power when climbing long or steep hills. Downshift just before the engine begins to labor. Don't wait until it has almost stalled.

Using second gear going down a long or steep hill saves wear on the brakes, since the engine helps slow the car down. Let the clutch out after every downshift.

Turning Your Vehicle

There are certain things to do when making a turn:

1. Decide in advance where you want to turn. Never make a "last minute" decision to turn. It is too dangerous.
2. Look behind you and to both sides to see where other cars (or people) are, to determine if it is safe to turn. A "last-minute" decision does not allow you time to take these steps.
3. Signal first and then move into the proper lane. Use directional signals if your vehicle is so equipped; if not, use hand signals. Some very safety conscious drivers use both mechanical and hand signals for added protection. The faster the traffic is moving, the sooner you should get into the proper lane for the turn you plan to make. The law requires you to signal at least 100 feet before making any kind of turn.

4. Slow down before reaching a crosswalk at an intersection. Make certain no pedestrians are in the way before you turn. Keep a constant speed and follow pavement markings in making a turn. Always finish your turn in

Handling Your Vehicle in Turning

First, let's describe the proper way to handle a car with a straight gear shift since it involves more actions on the driver's part. In slowing down, chances are you will need to shift into second gear to maintain a constant speed. Some drivers get in the habit of leaving their left foot on the clutch or "riding it" as the turn is being made. Take your foot completely off the clutch and after you have made your turn and are ready to return to your normal speed, then push the clutch and shift to high gear.

If your vehicle has an automatic transmission, then the action described above is not required.

It is important for anyone making a turn of any kind to keep both hands on the steering wheel at all times. Steer your car in the proper lane.

Right Turns

When you prepare to make a right turn, signal at least 100 feet ahead and approach the corner slowly, staying close to the right curb or edge of the roadway. Watch for people getting out of cars and opening car doors. Remain close to the right curb, or parked cars at the curb, while making your turn so that you will be in the right lane when the turn is completed.

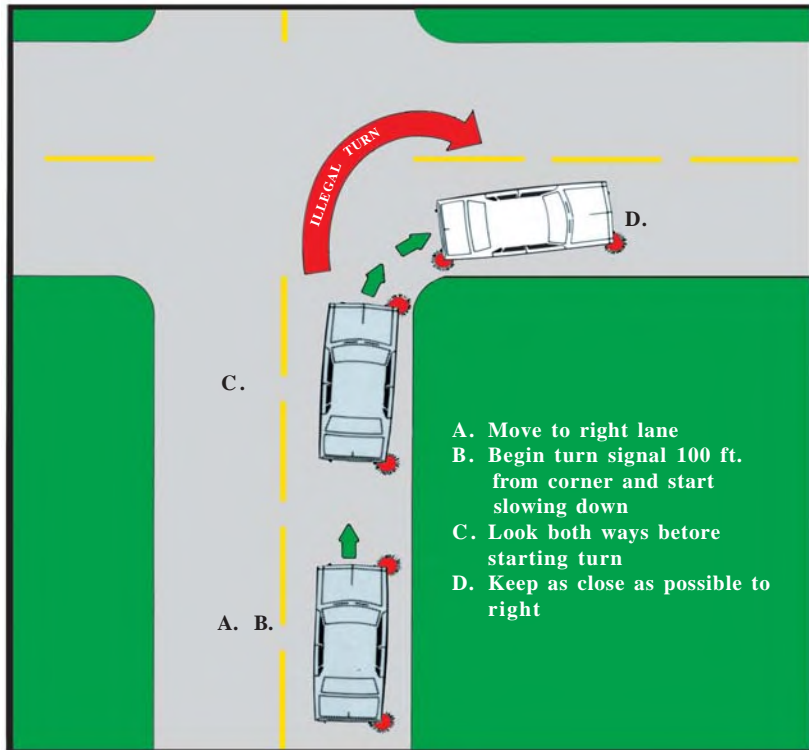

Right Turns

When you prepare to make a right turn, signal at least 100 feet ahead and approach the corner slowly, staying close to the right curb or edge of the roadway. Watch for people getting out of cars and opening car doors. Remain close to the right curb, or parked cars at the curb, while making your turn so that you will be in the right lane when the turn is completed.

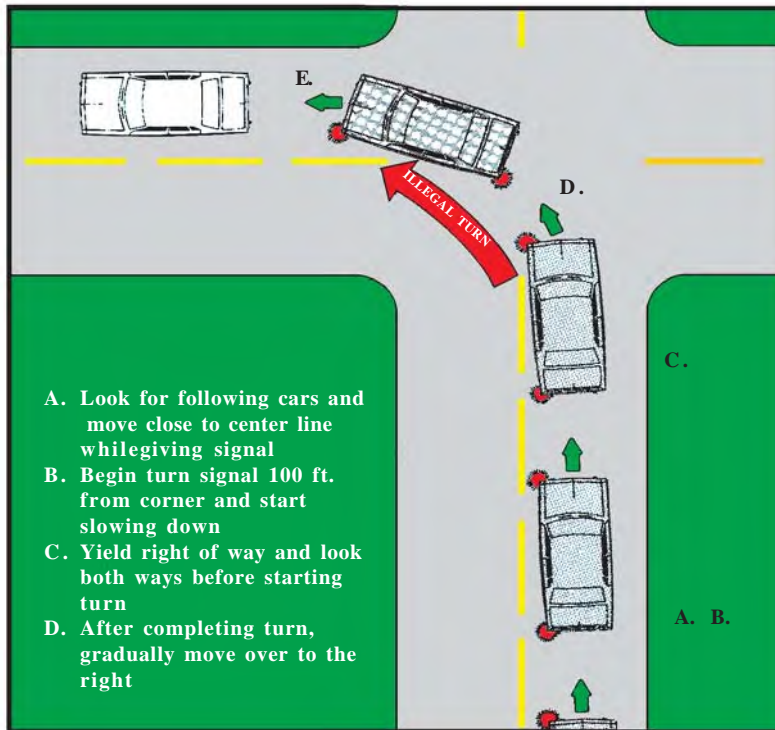

Left Turns

A left turn often takes more preparation than a right turn. You must think far enough ahead to get into the lane nearest the center of the road. Signal at least 100 feet ahead. Before turning, check traffic behind and in front of you. Make sure that no one is trying to pass you. Then enter the intersection from the lane nearest to the center line. Then turn into the lane nearest and to the right of the center line. Yield to pedestrians and oncoming traffic.

On a two-lane highway, the left turn should be made from as near the center line as possible and then follow the steps in the preceding paragraph.

Should the light turn red when you are in the intersection about to turn left, complete the turn when approaching traffic has cleared.

Left Turn-Two Vehicles

When you are meeting another driver at an intersection and both of you want to make a left turn onto the same street but going in opposite directions, then each should pass to the left of center of the intersection. It is illegal to make a left turn by keeping to the right of the center of the intersection, unless impractical to do otherwise or traffic control devices require a different path.

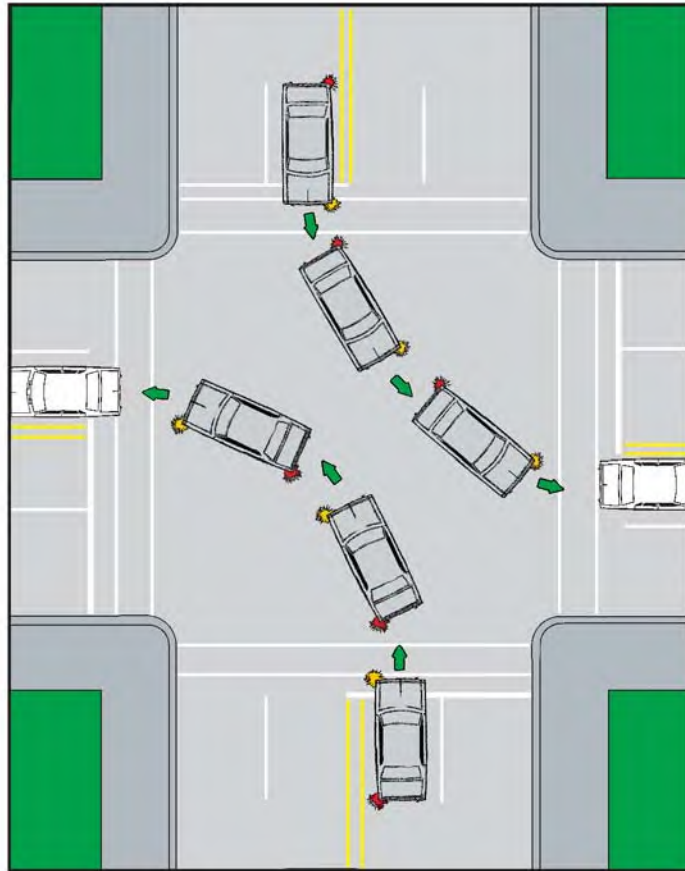

The above illustration shows the proper way for two cars to make a left turn in opposite directions. The cars should pass each other on the left side of the center of the intersection.

Left Turns-Non Intersection

At locations between intersections, left turns are made with the same preparation and precaution as at an intersection location. Solid yellow lines in your lane prohibit passing but may be crossed to enter driveways. On some streets there will be a “median” from which you should make your left turn, out of the way of other traffic. If there is a raised or grassed median, it will be necessary for you to use paved spaces to make your turn.

A two-way left-turn is a special lane marked for left turns by motorists traveling in opposite directions. When such a lane is designated by traffic-control devices, a left turn may be made only from this lane and may be driven in only when preparing for and making a left turn.



No Turns

You must never turn around while on or near any curve or hill. Your car or truck must be seen by other drivers approaching from either direction for at least 500 feet. Furthermore, when a turnaround or U-turn is not otherwise prohibited, you may not turn to proceed in the opposite direction unless the turn may be made safely and without interfering with other traffic.

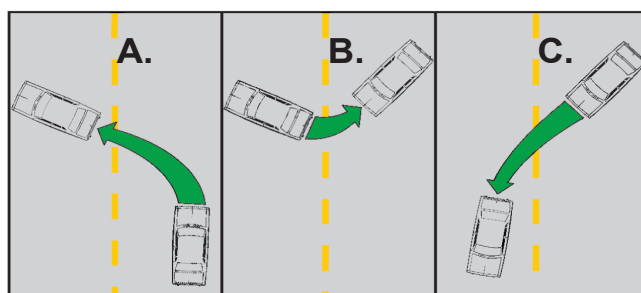

- A. Give proper signal and stop the vehicle close to the right edge of the pavement. Check traffic by looking over your left shoulder to see traffic behind you and cautiously turn the steering wheel all the way to left. Pull forward to the left.
- B. Back toward the opposite side of street.
- C. Pull car into proper lane.

Three-Point Turn

Never turn around on a busy street. It is better to circle an entire city block.

1. Give proper signal and stop close to the right edge of the pavement.
2. Look over your left shoulder and check traffic behind you. Do not depend on your rearview mirror alone; be sure the way is clear both ahead and behind.
3. Signal for a left turn. Then follow the steps in the illustration above. You will hear this type of turn referred to as a three-point or “Y” turn, as shown in the illustration.

When performing this maneuver, all approaching traffic will have the right of way. The three-point turn must be performed without hitting the curb, driving off the road surface, or using a side street or driveway.

When To Use Your Horn

The horn of your vehicle should be used for warning purposes. Be on alert to sound your horn to get the attention of pedestrians and motorists.

Signals For Stops, Lane Changes And Turns

You must give a proper signal for any change in direction or lane, or for stopping, by either mechanical or hand signals. Make certain your mechanical signals are in good working order.

The proper signals should always be used in driving from a curbside parallel parking space into the flow of traffic, and also in moving over into another lane or to pass another vehicle. The proper signals should be given when returning to the right lane.

South Carolina laws require most types of vehicles to be equipped with signal lights and that drivers know the correct hand signals that apply to turning and stopping. They are:

1. Left turn: Hand and arm extended straight out.
2. Stop or decreased speed: Hand and arm extended downward.
3. Right turn: Hand and arm extended upward.

These hand signals are recognized nationally. Extend your arm well out of the car window when giving signals. Turn signals must be given at least 100 feet in advance.

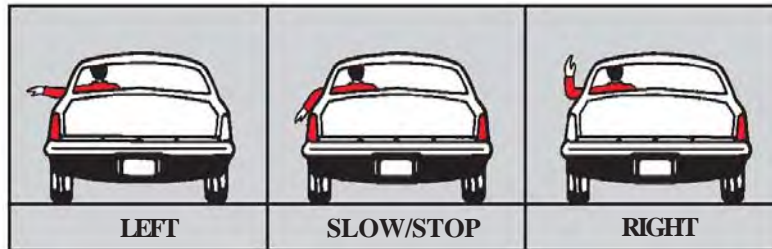

It is illegal to flash turn signals:

1. On one side on a disabled vehicle.
2. As a “do pass” signal to other drivers.
3. Because the vehicle in front is going to turn.
4. On a parked vehicle unless preparing to start off.

When driving, never put your hand out of the window except to give a signal. Keep both hands on the steering wheel at all times and be ready to stop in an emergency.

Stopping

You must stop:

1. At an intersection or railroad crossing controlled by a stop sign.
2. When a traffic officer orders you to stop.
3. When there is a “yield” sign on the road you are traveling and traffic on the intersecting road is too close for you to enter safely. Once the way is clear, then proceed. A yield sign may also be seen at a railroad crossing. In that instance, you must yield if there is an approaching train.
4. When coming from an alley, private driveway or building in a residential or business district, before driving across the sidewalk.
5. Where there is a traffic signal and the light is red. Wait until the light is green before moving ahead. The green light, however, does not automatically give you the right of way. It is an invitation to proceed when the intersection is clear. Most accidents at traffic signals occur in the first few seconds of change. One driver fails to observe an error made by another. When a yellow light shows, following a green light, you should prepare to stop. If you are already in the intersection, clear the intersection as quickly as possible.
6. Where there is a flashing red light.
7. At a bridge span that is about to open for boat traffic.
8. When a pedestrian is using a white cane.
9. When an approaching authorized emergency vehicle (fire truck, ambulance, police car, etc.) gives visual and/or audible signals, after first driving your vehicle to the right side of the road as far as is practical.

You should not stop when meeting a funeral procession, unless you are required to do so by a police officer, but continue driving with caution.

Four-Way or Multi-Way Stops

The most common usage of stop signs is found at the intersection of two streets where traffic on one street must stop and traffic on the other street does not, thereby favoring the flow of traffic on the more important street.

Another situation is at an intersection where all streets have stop signs. When this occurs, a sign reading “4-way” or “Multi-Way” is added to the stop signs. A motorist arriving at the intersection must yield the right of way to motorists who arrived before him, waiting his turn to enter the intersection. If two motorists arrive at the same time, if on different streets, the driver on the left should yield to the driver on

the right; or if on the same street, a driver desiring to turn left should yield to the driver from the opposite direction.

Following Other Cars

Rear-end crashes are very common at intersections and they can be avoided. The leading cause for these crashes is following other vehicles too closely.

When following another vehicle on any street or highway, use a minimum of three to four second following interval. If any unusual conditions exist, such as rainy weather or increased traffic, add an additional second.

To give yourself a three to four second following distance from the vehicle ahead of you, watch as the vehicle passes a stationary object such as a sign, pole or tree. Count the seconds it takes you to reach that the same point (“One-thousand-one, one-thousand-two, one-thousand-three). If you pass the object before you finish counting, you are following too closely.

Always drive more slowly and allow more following distance when pavement is wet or icy and when driving in fog.

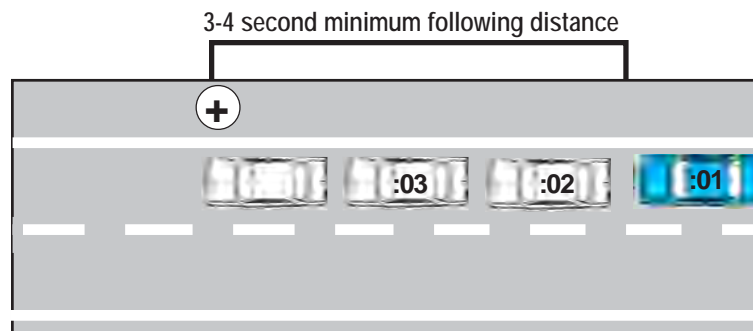

Parking

When parking parallel, you must maneuver your vehicle so that it is not more than 18 inches from the curb. Be sure to center your car in the parking space, clearly between the lines. Study the diagram before attempting to parallel park. When leaving a parking place, signal, use your mirrors and look over your shoulder to check traffic. Yield right of way.

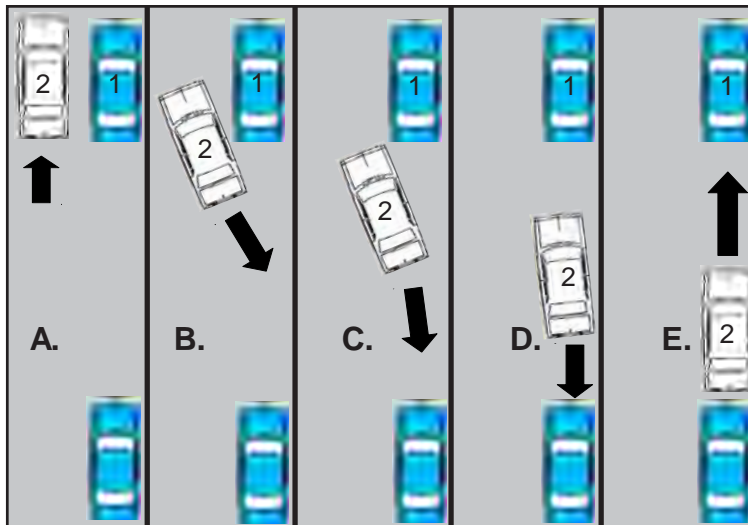

- A. Car 2 pulls even with car 1
- B. Car 2 maneuvers gently toward the space
- C. Car 2 turns wheels sharply
- D. Car 2 begins straightening wheels
- E. Wheels on car 2 should be straight unless parking on a hill

Angle Parking

This is perhaps the easiest type of parking. Your only task is to drive your car into the parking space, which has lines on both sides, without touching either line. This type of parking does present greater hazards when you are backing out.

Parking On Hills

When parking on hills, you should do the following:

1. Headed downhill, with or without curb: turn wheels to the right (except when parking left on a one way- street).
2. Headed uphill, with curb: turn wheels to the center of the street with the back of the front tire against the curb.
3. Headed uphill, without a curb: turn wheels to the right so that the vehicle will roll off the road if the brakes fail.

In each case, the parking brakes should be set, the vehicle placed in the proper gear or park and the engine turned off. For a manual transmission, the car should be set in first or reverse. When leaving a parking space, signal, use your mirrors and look over your shoulder to check traffic. Yield right of way.

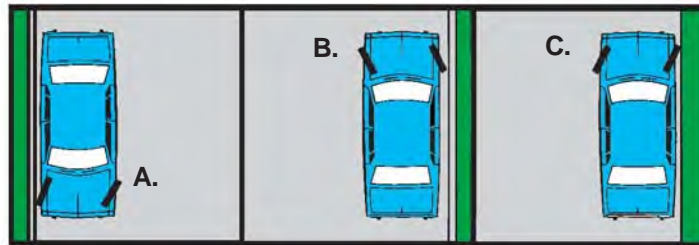

- A. Downhill with or without a curb, turn wheels toward curb
- B. Uphill with curb, turn wheels away from curb
- C. Uphill without curb, turn wheels to the right

Yielding Right of Way

Although there are laws governing right of way, you should never “demand” your rights in these situations, putting the fact that you are “right” ahead of your own safety and the safety of others. As a matter of fact, the law does not give anyone the right of way. It states only who does not have it. A good safety rule is to slow down before entering an intersection, look carefully to avoid a collision with other vehicles and once in an intersection, move on quickly to clear the way.

The term “right of way” refers to who shall wait and who shall yield at intersections or other places where two or more vehicles (or pedestrians) cannot all proceed at the same time.

The following rules tell you when you must yield to others or when others should yield to you.

1. When you are approaching an intersection at which there are no traffic signals or signs, you must yield to the other driver if he has already entered the intersection.
2. If two vehicles begin to enter an intersection at the same time and there are no traffic signs or signals, the vehicle on the left must yield to the driver on the right.
3. If you have entered an intersection and want to turn left, you must yield the right of way to approaching vehicles and any other vehicles already in the intersection. Make sure that no vehicle coming toward you is close enough for the turn to be dangerous.

- 
4. If you have stopped for a traffic light at an intersection and want to turn left when the green light appears, you must yield to traffic that is waiting on the opposite side of the traffic light. Never rush ahead and make a left turn in front of oncoming traffic.
 5. You may turn right at a red traffic light, unless a sign prohibits it; however, you must come to a complete stop first, and then cautiously enter the intersection. You must also yield to all pedestrians and other traffic lawfully using the intersection.
 6. If you are entering a street or highway from a private or side road in a rural area, you must yield to vehicles on the street or highway.
 7. You are required to yield to authorized emergency vehicles, such as police cars, fire engines and ambulances, when these vehicles are giving a signal by siren or flashing lights. Pull to the right edge of the highway and stop.
 8. You must yield to pedestrians who have properly entered the intersection but who have not had time to clear it. This is one of the most frequent and serious driver violations in cities and towns.
 9. You must yield the right of way to school children entering or leaving a school bus.

Important Lane Passing Skills

As we continue to build more multi-lane highways, it is more important than ever to know the proper lanes for normal driving and how to safely change from one lane to another. There are different rules for passing other vehicles for two-lane, multi-lane and interstate driving.

1. On a two-lane road, it is necessary that you stay in your proper lane. To straddle the center line or drive in the oncoming traffic lane can virtually guarantee an accident. Passing on a two-lane road must be done only when you have a clear view well enough ahead of you to make certain that you can safely pass without meeting an oncoming vehicle. A solid yellow line in your lane tells you it is dangerous and illegal to pass.
2. On a highway of four or more lanes, “straddling” a lane may not only be dangerous and discourteous, but is also illegal. You may be blocking traffic behind you. Official signs or traffic lights may direct you in a certain lane. Of course, you must always obey these signals unless a law enforcement officer directs you to do otherwise.

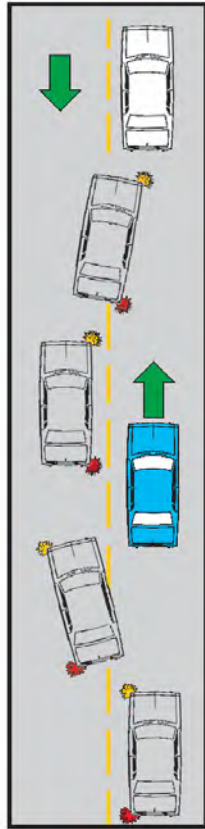

Proper passing sequence on two-lane highway.

On conventional highways (not interstates) that have grass or concrete medians separating opposing traffic, you must cross only at the paved spaces provided for this purpose. It is illegal to cross such a median at any other place. Paved medians that are surfaced with stone or pavement similar to the traveled lanes and outlined with painted lines may be crossed unless prohibited by a sign.

It is illegal to cross the median of interstates at any place; you must use an interchange. If you go past your turnoff, you must keep going until you reach the next exit; then, taking that, you can return to where you originally wanted to exit.

On a highway with four or more lanes, slower traffic should always use the outside lane (closest to the shoulder). Traffic should use the two right hand lanes except when passing. Where traffic is heavy on all lanes, it is better to stay in your lane and move along at the speed of other traffic, not exceeding the speed limit. Avoid the dangerous practice of unnecessary lane switching.

Passing Other Vehicles

On a two-lane road where opposing traffic meets without any type of protection barrier, passing requires more thought, action and caution. After you have made certain that there is no oncoming traffic:

- Look into the rearview mirror and your outside mirror to make certain there are no vehicles attempting to pass you.
- Turn your head quickly to the left, checking the “blind spot” over your left shoulder.
- When you are sure that all these are clear, observe the vehicle you are preparing to pass and make certain he is staying in his lane.
- Give your left turn signal.
- Quickly check again to be sure there is no oncoming traffic.

- Pull over the center line as you approach the other vehicle.
- Then go quickly around the vehicle you are passing.
If you need to exceed the speed limit to pass, you should not pass.

Wait until you can see both headlights of the other car in your rearview mirror and turn your head to check blind spots before returning to the right lane. Be sure to give a right turn signal before moving back into the right lane. Never “cut in” on the driver you have just passed.

No matter what kind of road, street or highway, always observe carefully what other motorists in the area are doing when you are passing. Good drivers are constantly on the lookout for unexpected actions of other drivers and pedestrians. A particularly important thing to watch for is any indication that the driver is not aware that you are passing him. Signal and then make certain he knows your intentions.

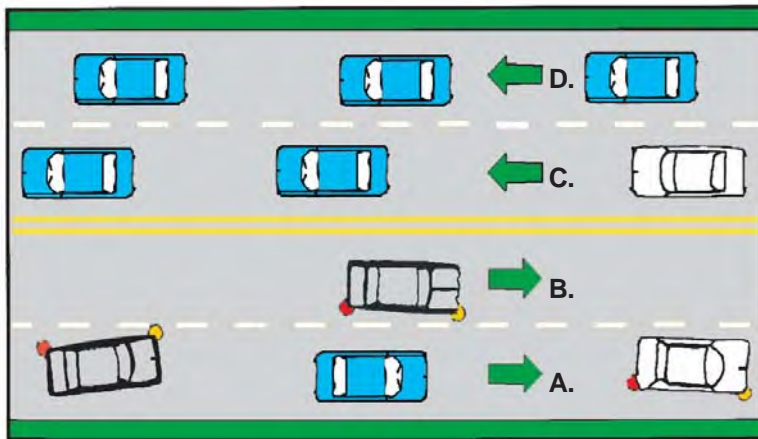

On a four-lane highway, slower traffic should travel in the right lane. As in lanes A and B, a motorist may pass another car or simply remain in center lane (in lane C) provided he/she is the fastest moving vehicle.

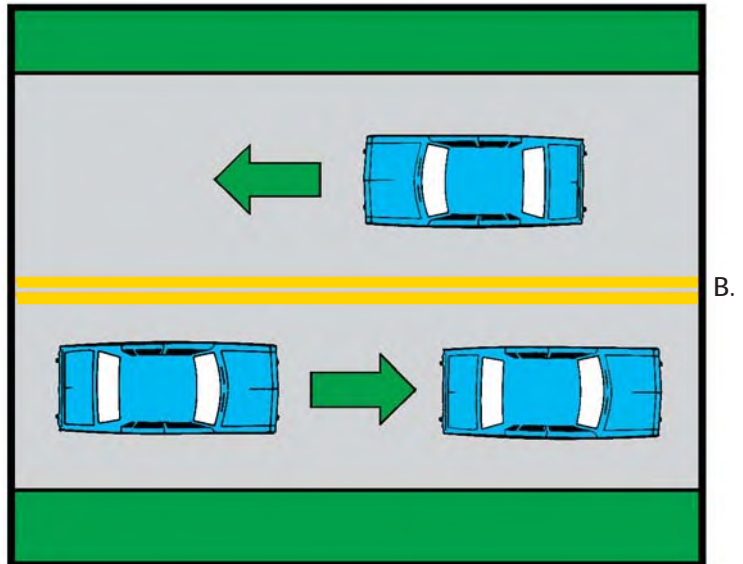
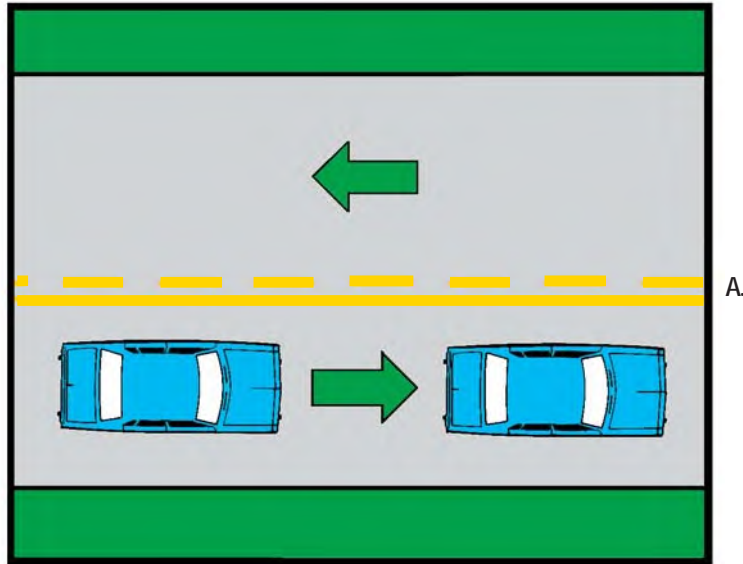

When broken yellow lines separate the lanes of traffic on a two lane highway, you can pass when there is no oncoming traffic. When a solid yellow line appears on your side of the center line (ill. A), do not pass. When there are two solid yellow lines (ill. B), passing is not permitted in either direction.

Passing On Right

In most cases you pass another vehicle by moving to the left. There are times, however, when it is permissible to pass a vehicle on the right:

1. When the other vehicle is making a left turn and there is room on the paved portion of the roadway.
2. On a street or road where the way is wide enough and clear ahead, with no parked cars obstructing the way or “hiding” pedestrians, and where the pavement is wide enough for two or more lanes of traffic in the same direction. Use caution and observe what other drivers and pedestrians are doing, so that any abrupt action on their part will not catch you unaware. Passing on the right is permissible only when movement can be made safely and without driving off the roadway.

When Being Passed

When a driver is passing you, be on guard so that you may protect yourself from any of his potentially unsafe actions. Maintain speed and position when being passed, unless the driver must return to your lane because of an oncoming car. Then slow down when he speeds up or speed up if he slows down.

When Not to Pass

It is illegal to drive to the left of center to pass a vehicle in the following places:

1. On a hill or a curve, or at any place where you cannot see far enough ahead to pass safely. According to the law, you must have clear passing distance so that you can pull back into the right lane at least 200 feet before meeting an oncoming vehicle.
2. At a street crossing or highway intersection.
3. At any railroad crossing.
4. When meeting another vehicle close enough to constitute a hazard.
5. Where a sign tells you not to pass.
6. When a vehicle in front of you has stopped to let a pedestrian cross (even if the pedestrian is crossing illegally).
7. In an area where road construction or maintenance work is underway and passing would be hazardous to the road workers, to you or the other motorists.
8. When a solid yellow line is in your lane.

A. Do not pass on a hill

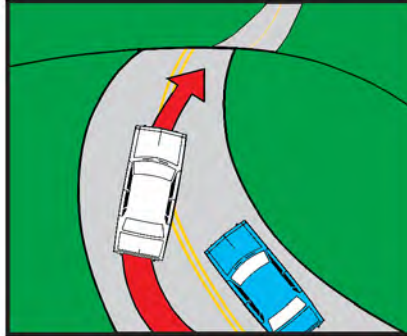

B. Do not pass at an intersection

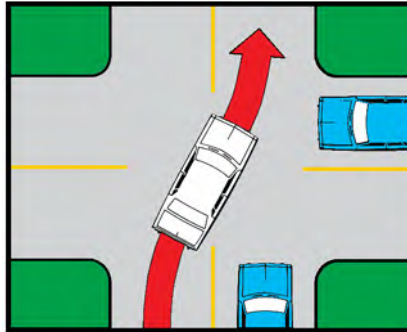

C. Do not pass within 100 feet of a bridge or tunnel when view is obstructed

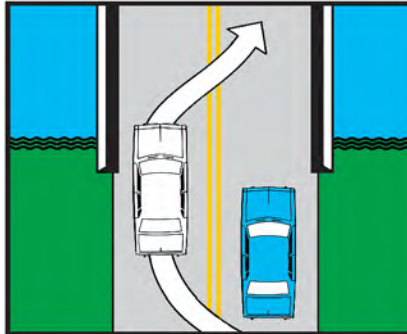

D. Do not pass on a curve

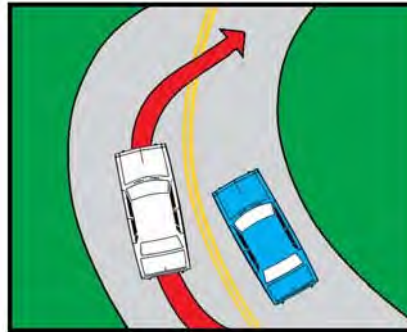

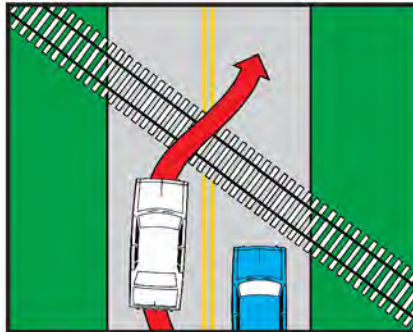

E. Do not pass near railroad crossings

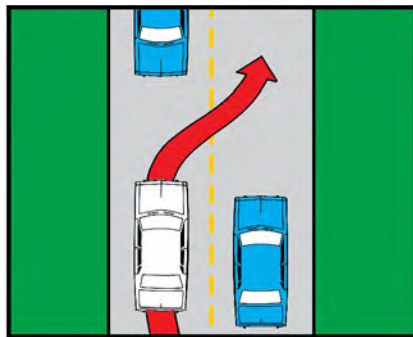

F. Do not pass when there is oncoming traffic

Interstate Driving

Interstates require sharp driving skills, along with more preparation, in order to drive safely. The basic feature of an interstate is that access to it is controlled. You can get on or off only at special places known as interchanges.

Entering An Interstate

The entrance ramp is a short one-way road that leads to the interstate. Once on the entrance ramp, you should begin checking traffic on the interstate.

Check traffic by using your rearview mirror and outside mirror as well as quickly checking over your shoulder for the blind spot. Watch the vehicle in front to be sure it is not stopping on the entrance ramp. (Vehicles on the interstate have the right of way, but courteous drivers will permit you to move into the interstate traffic.) From the entrance ramp, you should move into the acceleration lane. This is the lane that runs alongside the main roadway. On the acceleration lane, you can

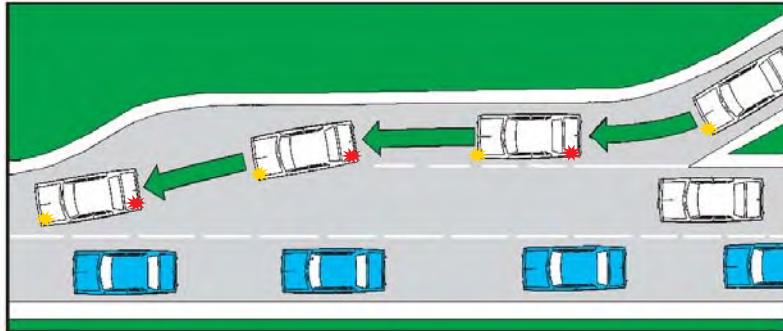

Entering Highway

Using the proper signal, carefully come down the entrance ramp moving onto the acceleration lane, watch for gap in the traffic and ease into that gap so that you do not have to stop on the entrance ramp or acceleration lane.

pace your speed to the speed of interstate traffic. When you find a large enough gap between vehicles, you should move into the gap as smoothly as possible.

You should not come to a full stop on either the entrance ramp or the acceleration lane. Once onto the interstate, drive with the flow of traffic as much as possible, but do not exceed the speed limits.

Driving On The Interstate

Posted speeds on these roads are for good driving conditions. When the weather changes (fog, rain, snow, etc.) you must slow down and drive at a speed safe for conditions. The most important thing is to drive with the flow of the traffic at all times, but do not exceed the posted speed limits.

Know Your Lanes

Driving in the proper lane on a interstate is a “must” for safety. The extreme right lane is usually for slower speeds and also for entering and leaving the interstate. The other lanes are usually for motorists who want to drive and maintain the posted speed limit. However, if another vehicle overtakes you from the rear you should pull over to allow him to pass.

Changing Lanes

Before changing lanes to pass, carefully check all traffic conditions around you. Use your rearview and outside mirrors, and quickly check over your left shoulder for the blind spot. At interstate speeds, vehicles can quickly come up on you from behind, so change lanes with care, signaling your intention to change lanes at least 100 feet in advance.

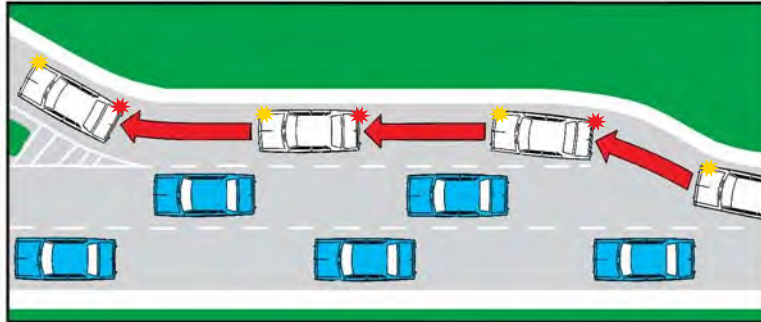

Leaving Highway

Get into right lane. Signal your intentions. Once in the deceleration lane, slow down gradually so as to be at the exit speed when the exit is reached. Motorists who mistakenly drive past an exit should never stop on a interstate, but should go on to the next exit and come back to the exit they missed.

Driving Too Slowly

The slowest speed you may normally travel on a interstate is posted. Sometimes, especially when the weather is good and traffic is light, even this can be too slow. Most important, drive with the flow of traffic as long as the traffic is not exceeding the posted speed limit.

Stay Well Behind

With high-speed traffic it is extremely important to stay well behind the vehicle in front of you. Of course, in some traffic congestion this is not always possible. But remember: the faster the speed, the longer it takes to stop when you must react to other drivers' unexpected moves.

Rush Hour Driving

This is sometimes a very frustrating type of driving. One little "fender-bender" accident can clog the interstate for miles. If you are involved in such an accident and your vehicle is dangerously obstructing traffic, move your vehicle to a safer position of the highway if possible, so that other traffic can resume its normal speed. Also if you are traveling past an accident scene, don't stop or slow down to a crawl to see what is happening. Often, curiosity seekers are the biggest offenders in clogging rush-hour traffic.

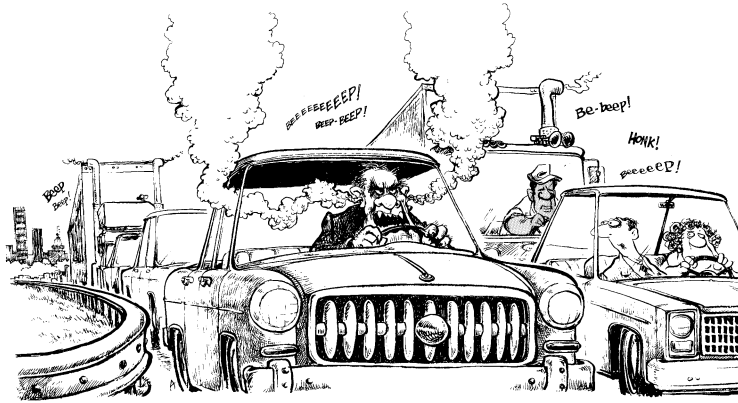

Keep your cool in rush hour traffic.

When Emergencies Occur

If you have trouble and must stop, drive entirely off the traveled portion of the interstate and give a signal that you are having difficulty. Get out of your vehicle on the right side if at all possible. Otherwise a passing motorist may not see you in time to stop. If you have one, tie a white cloth to a left door handle of your vehicle. Raise the hood to indicate trouble.

Since there is always a possibility that you may have to make an emergency stop, it's a good idea to carry a flare or flashing light in the trunk of your vehicle. (If you use a flare, place it about 75 feet behind your vehicle to warn other traffic.)

One of the major reasons for planning your trip ahead is to know exactly where you want to leave the interstate. This move has to be planned well in advance. When you see the sign indicating that your exit point is nearing, begin preparing for it. Signal and move into the correct exit lane as soon as it is reached. Once you're in the deceleration lane, reduce your speed gradually in order to be at the exit speed. (Do not drop your speed below the minimum speed while in the main traveled portion of the highway.)

Some exits are made from the extreme left lane. Posted speed limits are usually based on the design of the particular exit ramp.

Tips for Interstate Driving

1. When entering an interstate, increase your speed while in the acceleration lane up to a speed that will permit you to move into a gap between vehicles.
2. Yield to other cars already on the interstate but try not to bring your vehicle to a complete stop.
3. Backing on an interstate is illegal, dangerous and can cause a serious accident.
4. After leaving the interstate, be sure to adjust your speed downward for other types of highways. Continue to check your speedometer closely.

Primary Highway Driving

Defensive driving is particularly important on the primary highways. The majority of traffic accidents and deaths occur on the state's primary highways when the weather is good and the roads are dry.

These highways are usually in good condition. Many of them have four or more lanes and it seems that since danger is not apparent, many motorists are lulled into a false sense of security and have lapses that bring about accidents.

It is important to stay alert on these highways. Remember that even though they may have four or more lanes, unlike the interstates they do not have controlled access. That means a vehicle could dart in front of you from an intersecting street, a place of business, a residence, behind a parked vehicle and so forth.

Keep your eyes moving, and keep your mind alert; let anticipation be your key word. Always be ready to react to the unexpected.

Secondary Road Driving

Because many of our secondary roads do not carry heavy traffic, drivers may often be lulled into a sense of false security on these roads. You may go for miles and not see a vehicle, and you begin to think that you have the road to yourself. Then, suddenly there's a crossroad ahead where another vehicle has the right of way and you have not given yourself enough time to stop.

Defensive driving is a must on these roads, just like any other highway in South Carolina.

Proper Method Of Braking

Although it may seem that applying the brakes of a vehicle is a simple thing, it is not. The most common mistake that a person learning to drive makes is braking too hard, causing the vehicle to jerk to a stop. The task is to learn to apply the brakes gently with increasing pressure until the vehicle comes to a gradual and smooth stop.

Braking, like all other practical tasks in the art of driving, improves with patience and serious practice. Once the skill is learned, you will be able to stop your vehicle as quickly or as gradually as you choose when driving at a proper speed. Use your right foot for both braking and accelerating your vehicle.





Trucks and Recreational Vehicles



Truck Class Licenses

South Carolina issues licenses as proof that you've been examined and are qualified to operate a particular type of vehicle. You must be at least 18 years of age to apply for one of the following licenses:

Commercial

Class A: Any combination of vehicles with a GCWR of 26,001 or more pounds provided the GVWR of the vehicle(s) is being towed is in excess of 10,000 pounds.

Class B: Any single vehicle with a GVWR of 26,001 or more pounds, or any such vehicle towing a vehicle not in excess of 10,000 pounds GVWR.

Class C: Any single vehicle, or combination of vehicles, that does not meet the definitions of Class A or B, but either is designed to transport 16 or more passengers, including the driver, or is placarded for hazardous materials.

For information about a commercial driver's license, please see the [South Carolina Commercial Driver License Manual](#).

Non-Commercial

Class E: Allows the same driving privileges as a Class D (regular passenger vehicle) and Class G (moped) licenses, plus single unit vehicles weighing over 26,000 pounds gross weight that do not meet the definition of Class A, B or C.

Class F: Allows the operation of all Class D, E and G vehicles, plus all other combinations of vehicles with a gross vehicle weight (GVW) in excess of 26,000 pounds that do not meet the definition of Class A, B and C.

The information in this section applies for Class E and F licenses, which do not allow a driver to operate a commercial motor vehicle.

If you plan to operate a motor home that weighs more than 26,000 lbs. GVW, you must obtain a Class E license. If you operate a motor home that weighs more than 26,000 lbs. and tow a trailer or other vehicle, you must have a Class F license. You may take the Class E and F knowledge tests at any SCDMV office. Due to the space required for a Class E or F skills test, these tests must be taken at one of the 36 SCDMV offices that offer commercial driver license testing.

During the basic skills portion of the Class F test, motor home operators will be allowed to disconnect the towed vehicle. However, the towed vehicle must be reconnected for the road test portion of the skills test.



The Licensing Procedure

The basic requirements for obtaining a non-commercial Class E or F driver's license are as follows:

1. You must pass an eye examination.
2. You must be physically and mentally able to drive.
3. You must understand the meaning of the different traffic signs, signals and pavement markings.
4. You must have your vehicle in good condition.
5. You must know and understand how to safely maneuver your vehicle on the streets and highways.
6. You must show you can respect the rights of other drivers, pedestrians, motorcyclists and bicyclists who share the road with you.
7. You must surrender your beginner's permit or current driver's license upon successful completion of the driving test.
8. You must be at least 18 years of age.
9. You will need to study all of the material in this guide (except the motorcycle and moped sections) in order to pass the test.

Driving Requirements

Some of the requirements of the driving test on which you will be graded are:

Good Posture

You will be expected to maintain good posture during your examination. Your ability to operate a vehicle properly and safely will depend in part on your seat adjustment. Your seat must be positioned so that you can adjust the mirrors for good visibility, reach the various foot pedals and have a controlled grip on the steering wheel.

Mirrors

Mirror use is vital. While driving a large vehicle, you should check your mirrors constantly to be aware of the traffic conditions around you at all times.

Starting From Parked Position

You must select the proper gear, operate the clutch smoothly, signal your intentions, and check your mirrors before leaving the curb area.

Clutch Operations

You must show familiarity and smoothness in operations.

Gears

You must select the proper gear and gear pattern and shift without clashing, forcing or snapping.

Braking

You must be able to stop your vehicle smoothly without a jerk or rebound at the end of the stop.

Following

You must keep a safe distance behind the vehicle ahead of you in case it should make a sudden stop.

Passing

You must be able to pass legally and safely without interfering with other traffic.

Lane Position

You must keep your vehicle in the proper lane without veering across the center line or off the right side of pavement.

Intersection

You must maintain the proper safe speed, looking in both directions, and be prepared to stop if traffic on the cross street fails to stop.

Turning

You must give proper signals and be in a proper lane position and at the proper speed when turning.

Stop Line

Stopping at a stop line will test your ability to judge the location of the front bumper so that you will not run over crosswalks and other areas where stops are required.

The Serpentine

You must be able to maneuver in and out of tight places.

Backing

You must be able to back your vehicle slowly for a distance of 100 feet as straight and smoothly as possible and to demonstrate use of the mirrors while doing so.

Alley Dock Backing

In this simulated maneuver of backing to loading platform, you must back your vehicle in a continuous movement into an area 90 degrees from the area you backed from.



Using Horn

Use the horn only when necessary to warn pedestrians, motorcyclists, bicyclists or others who share the road with you. You should use your horn also when backing.

Stopping And Starting On Grade

When a vehicle is parked, the parking brake must be set and the transmission placed in reverse, or the lowest forward gear. If there is a curb, the front wheels should be turned toward the curb on a downgrade or level surface and turned away from the curb when parking on an upgrade. If the steepness of the grade or other factors increase the danger of a runaway vehicle, you should use chock blocks. Never park on a steep grade unless absolutely necessary.

Standard Road Driving

Normal on-road driving practice.

Proper Driving Techniques

Pre-trip Inspection

Before the driving demonstration begins, the examiner, with your assistance, will inspect the vehicle and its equipment. You should check your vehicle before appearing at the examining station to make sure all equipment is operating properly. Drivers should inspect their vehicles before each trip. The driver is responsible for making sure that the truck is in a safe condition. Follow these procedures:

- **Step One: Initial Vehicle Check**

Enter cab using the three-point method for safety--having one foot and both hands on the truck at all times, or two feet and one hand.

1. Make sure your vehicle is secured properly.
2. Depress the clutch and place the gearshift in neutral.
3. Start the engine, and check:
 - A. Oil pressure gauge for proper pressure.
 - B. Ammeter.
 - C. Horn.
 - D. Windshield wipers.
 - E. Engine for unusual noises.
 - F. Air pressure.

With the engine running, build air pressure to 100-125 psi. Shut engine off. Release tractor protection valve and push parking brake in. Fully depress brake pedal; hold for one minute. Pressure loss should not exceed 3 psi for single vehicle, 4 psi for combination unit. Begin fanning

brakes; low air warning device (buzzer-light-flag) should activate before air pressure drops below 60 psi. Continue fanning brakes at approximately 40 psi. The tractor protection valve and parking brakes should close (pop out). If vehicle fails air brake check, the test will be discontinued. In the event the vehicle is equipped with vacuum or hydraulic brakes, depress the brake pedal and hold it down. If brake pressure will not hold, the test will be discontinued.

● **Step Two: Outside the Vehicle**

Set the parking brakes, turn on all lights, leave the cab and begin your equipment inspection. Start at the left front wheel and proceed around in a counterclockwise direction.

1. Lights and reflectors should be clear.
2. Check tires for wear and cuts and to ensure proper inflation.
3. Check the wheels for missing lug nuts.
4. Make sure the trailer landing gear is raised and the handle is secure.
5. Ensure that the fifth-wheel jaws and release lever are in the locked position.
6. Check brake lines for leaks and wear, and electric lines for excessive wear.
7. On combination units, check lights and brake connections between power unit and trailer by hand to make sure of tightness.
8. Check emergency warning equipment (you should have three devices).
9. Check general overall vehicle appearance (Are rear doors closed? Are there any loose fenders, torn metal, etc., exposed enough to be hazardous?).
10. Check the headlights (both upper and lower beams), directional signals, stoplights, emergency flashers. For these operations, you will re-enter the cab. The examiner will check these from outside.

● **Step Three: Inside the Vehicle**

1. Adjust the seat and then the mirrors.
2. With trailer brakes on, put the gear shift lever in the lowest forward gear, release the parking brake on the tractor and by gently releasing the clutch, check the coupling between the tractor and trailer. This procedure will also check the trailer brake. Check the tractor protection valve.
3. After checking the coupling between the tractor and the trailer, release the trailer brakes, then release the clutch pedal gently. With the vehicle in motion, check the foot brake.



Starting The Engine

1. Engage the parking brake, place the transmission in neutral, adjust the choke, and depress the clutch pedal.
2. Turn on the ignition, and operate the starter.
3. Control the engine with the foot throttle until it is running smoothly.
4. When the engine is running smoothly, set the hand throttle at a fast idle and allow the engine to warm up before attempting to move the vehicle.
5. On air brake vehicles, the air pressure gauge should register sufficient pressure before the vehicle is moved. The audible warning buzzer must have stopped and/or the warning light must be off.

Putting The Vehicle Into Motion

1. On a combination vehicle, test the hookup in one of the following ways before attempting to move the vehicle:
 - A. Place the transmission in reverse, partially engage the clutch and speed up the engine to make the power unit go backward smoothly until the fifth-wheel jaws engage the kingpin.
 - B. Apply the trailer brakes and pull forward to see if the fifth wheel is locked. Then check visually to see if it is secure.
2. Disengage the clutch and place the transmission in the lowest forward gear. If the vehicle is equipped with a trailer hand control, pull it down to set the trailer brakes to keep the unit from rolling. If there is no hand control, leave the trailer parking brake set. When starting, gradually release the clutch while releasing the hand control valve or the parking brake as the clutch engages. At the same time, press the accelerator gradually to prevent stalling and to move the load. Do not ride the clutch when it is finally engaged and the vehicle is in motion.
3. The foot brake must be checked immediately after the vehicle is moving, within at least 50 feet during the road test.

Shifting Up Through The Gears

In each gear, sufficient speed must be built up to avoid lugging the engine in that gear and speed must be sufficient so that engine will not be lugged when the next higher gear is reached.

Double-clutching may be used on most manually shifted truck transmissions except synchro-mesh transmissions. Shifting is faster and smoother when this procedure of depressing the clutch twice with each change of gears is used.

Shifting Down

Be alert to changing conditions that may require a reduction of speed and shifting down a gear. Do not wait until the engine starts lugging before shifting down. For dangerous down-grades, the gears should be downshifted to make use of engine-braking.

A good driver will downshift before passing the crest of a hill since it is dangerous to downshift past this point. Missing a gear can be dangerous.

If your brakes fail on a level road, you should shift to a lower gear and use engine compression to assist you in stopping the vehicle.

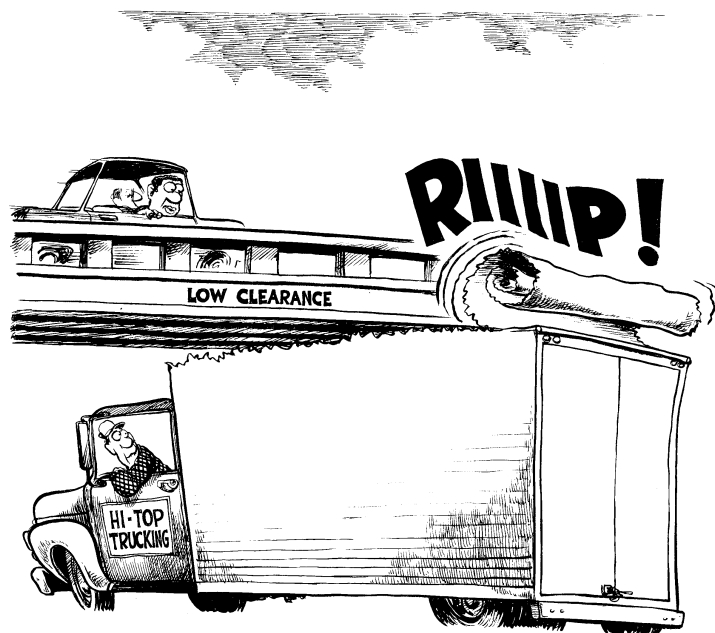

Be aware of your truck's measurements to avoid surprises.

Passing

1. Passing should be attempted only when you have clear and adequate space ahead to complete the pass without racing and without risk to yourself or the vehicle being passed.
2. A signal must be given 100 feet before pulling out to pass. Signal before returning to the right-hand lane when changing lanes.
3. Return to your lane when you can see both headlights of the vehicle being passed in your side-view mirror.
4. On multiple-lane highways, don't pass if you would block faster traffic overtaking from the rear.



- A. Give proper signal 100 ft. or more before pulling out to pass.
- B. Give proper signal before returning to right hand lane.

Being Passed

1. When being passed by another vehicle, keep well to the right side, maintain your speed and, if necessary, reduce speed to facilitate safe passing. Never speed up to prevent another driver from passing.
2. Do not signal the driver of an overtaking vehicle that is safe to pass. This is a dangerous practice and is prohibited by the U.S. Department of Transportation. To give such a signal transfers part of the responsibility for safe passing from the overtaking driver to yourself. If an accident occurs after you have given a signal, you could be held liable for any damages.
3. Be alert for the driver who tries to pass in a unsafe place. Don't try to block the passer and be ready to do anything that may be necessary to avoid being involved in an accident.
4. At night, dim your lights after being passed to avoid creating a glare in the other driver's mirror.

Meeting Other Vehicles

1. Always keep to the far right when meeting any oncoming vehicle. At night, dim your headlights 500 feet from any oncoming vehicle regardless of any action its driver may take.
2. If you see a vehicle approaching on your side of the road, slow down and pull as far to the right as safely as possible and stop. Never pull to the left in an attempt to avoid an oncoming vehicle in your lane.
3. Always sound your horn to warn the driver ahead when you are passing. Headlight signals alone are not a legal warning and must not be used as such.
4. When it is safe, return to the right-hand lane.
5. Never attempt to pass a vehicle when approaching the top of a hill, curve, intersection, side road, bridge, railroad crossing or any place where you do not have a clear view of the road ahead. Make sure you can see the traffic approaching from the side.
6. Standing buses must be passed in accordance with local traffic regulations.
7. Be alert for school buses and ready to make a safe stop if necessary. You must stop for a stopped school bus with flashing lights that is



loading or unloading passengers. This is required by law whether you are meeting the bus or traveling behind it under the following conditions:

- a. On any two-lane highway.
 - b. On any four-lane or multi-lane highway only when traveling behind a school bus.
 - c. When passing a school bus that has red or amber signals flashing.
8. Do not attempt to pass unless there is sufficient difference between your speed and the speed of the slower vehicle so that you can pass without delay.
 9. Do not attempt to pass more than one vehicle at a time. If you try to pass a line of traffic, you may find yourself in a position where you cannot return to the right lane should the need arise.
 10. On multiple-lane highways, take care not to pass when you would block faster traffic overtaking from the rear. On highways with three or more lanes of traffic in the same direction, use only the two right-hand lanes unless passing or when making a legally permitted left turn.

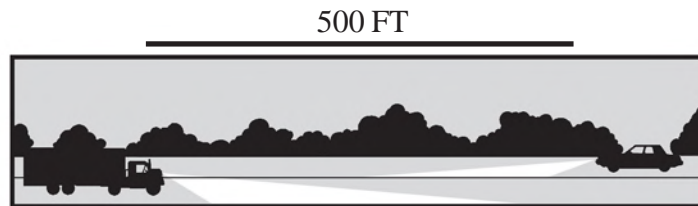

Drivers are required to dim headlights 500 ft. from any approaching vehicle, 200 feet from any vehicle you are approaching from the rear.

Use of Mirrors

1. A professional driver watches his mirrors nearly as much as he watches the road ahead. Vision is restricted when using mirrors. As a precaution, you should always check for traffic with and without mirrors.
2. Proper adjustment of mirrors is essential in safe driving. To adjust mirrors accurately on a combination unit, the vehicle must be in a straight line. The driver must be in a normal position behind the steering wheel while making adjustments.

Use of Brakes

1. Allow sufficient distance to avoid the need for sudden stops.
2. Apply brakes with steady pressure at the beginning of a stop and then gradually release as the vehicle slows down.

3. Do not fan brakes except on slippery pavement. Fanning brakes on a long downgrade may reduce brake air pressure below the minimum pressure needed for proper brake operation.
4. Avoid excessive use of brakes on long downgrades. Use engine compression as the principal means of controlling speed on long downgrades and in the mountains.

Yielding Right Of Way

The driver of a vehicle must never “demand” the right-of-way. When approaching an intersection all drivers must exercise due care. The law does not give anyone right-of-way over another; it states only who should yield.

Following Other Vehicles

Drivers should make a habit of never driving too closely behind other vehicles. Allow enough space between you and the vehicle ahead that you can stop easily and safely in an emergency. Always keep in mind adverse conditions such as weather and roads; traffic conditions may require more cautious driving.

Leave enough space between you and the vehicle ahead to allow faster traffic to pass you and return to the right lane. Whenever conditions permit, a truck should not follow another truck or any motor vehicle pulling another motor vehicle closer than 300 feet. At night, if the following distance is within 200 feet, the law requires that you dim your headlights.



Routine Driving Tasks

Many of the routine driving tasks that you face in driving a truck or recreational vehicle will be similar to driving a car. For the sake of all road users, it is important to be a defensive driver when driving any vehicle.

Curves

Maneuvering around curves and turns in trucks and recreational vehicles requires more skill and care than in cars. Curves and turns must always be executed at a reduced speed consistent with the

available sight distance, the sharpness of the curve or turn and other prevailing road and traffic conditions.

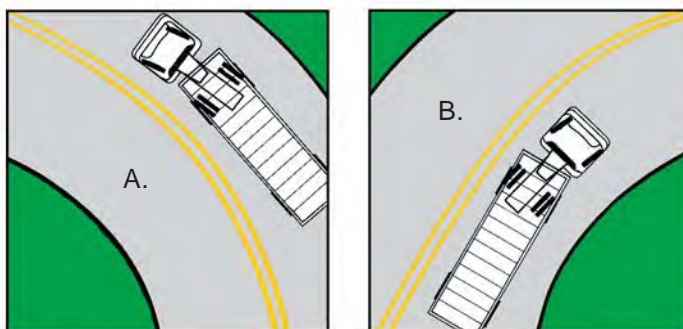

Illustration A shows proper execution for taking a left curve and B, a right curve.

On sharp or right curves, you must lead the turning arc of the front wheels in keeping with the sharpness of the curve and the amount of off-track of your vehicle. On a curve to the right you must keep your front wheels close to the center line to prevent dropping the rear wheels off the pavement or breaking the pavement shoulders. On a curve to the left you must keep your front wheels close to the right edge of the pavement to prevent the rear wheel from crossing into the other traffic lane.

When entering a curve, you must make sure that the speed of your vehicle is slow enough for you to retain control in the curve. If you apply your brakes in a curve your vehicle may skid or jackknife. You may gradually accelerate on a curve only after you have passed the midpoint of the curve. You must enter a curve at a speed that doesn't require braking. Failure to do so greatly increases the chances of "rolling-out", skidding or jackknifing.

Different Turning Characteristics

The difference between the turning characteristics of a single-unit vehicle, a tractor semitrailer or combination unit are shown in Illustrations A and B.

In Illustration A, note that the rear wheels of the truck follow a shorter path than the front wheels.

In Illustration B, note that the rear wheels of the tractor follow a shorter path than the front wheels of the tractor in turning the corner shown in Illustration A.

The rear wheels of the semitrailer or combination unit follow a still shorter path cutting this corner. Drivers must allow for off-tracking of the rear wheels. The longer the vehicle or combination, the greater the off-track.

Turns

1. Know where you want to turn ahead of time. Never make a last-minute decision. Check both mirrors for other vehicles and pedestrians to determine if it is safe.
2. It is important to signal your intentions 100 feet before turning. Be sure your signal light is off after completing the turn. Failure to do so tends to create confusion for other drivers.
3. There will be times when faster moving traffic will require you to move into the proper lane much sooner than you ordinarily would in order for you to make a safe turn.
4. Be sure to follow the pavement markings when possible and finish your turn in the proper lane.
5. A major concern while turning will be your “off-track.” On any turn the rear wheels will follow a shorter path than the front wheels. The illustrations will give a clear understanding of your off-tracking position.
6. When executing a right turn, be sure your rear wheels do not run up on and over the curb.

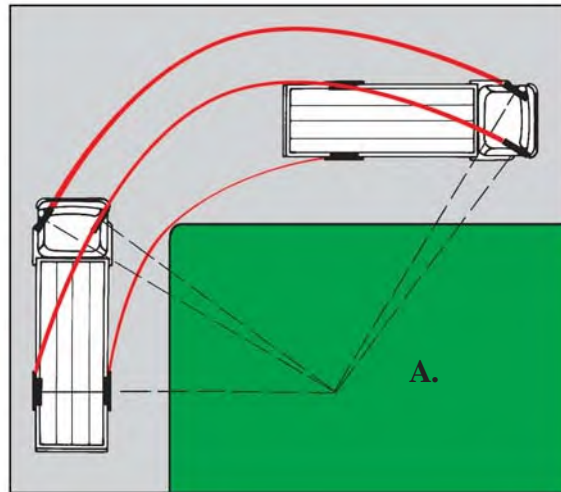

In illustration A, notice the rear wheels of the single-unit vehicle follow a shorter path than the front wheels

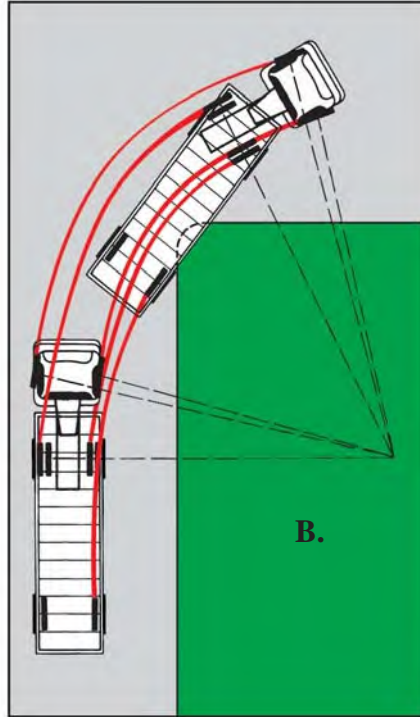

In illustration B, notice the rear wheels of the trailer follow shorter paths than the front wheels of the tractor.

Right Turns

1. Single-unit vehicles or buses must signal 100 feet before the turn and enter the turn as near to the right curb as possible. Operators of large vehicles must bear in mind that the off-track of the rear wheels will follow a shorter path than the front wheels. You must allow for this on all turns so that your vehicle does not strike another vehicle or a stationary object. Be careful about swinging wide to make a right turn. There is danger that some other driver will try to pass on the right. If you must make a wide turn, the swing should be made wide into the street you are entering.
2. Combination vehicles follow the same procedure in turning as single-unit vehicles, except that the off-track will take a shorter path while turning and the swing-out must be greater. A hazard of the swing-out is the possibility of a vehicle passing on the right. There will be times when you'll have to stop and allow other vehicles to clear the lanes that you are about to enter.

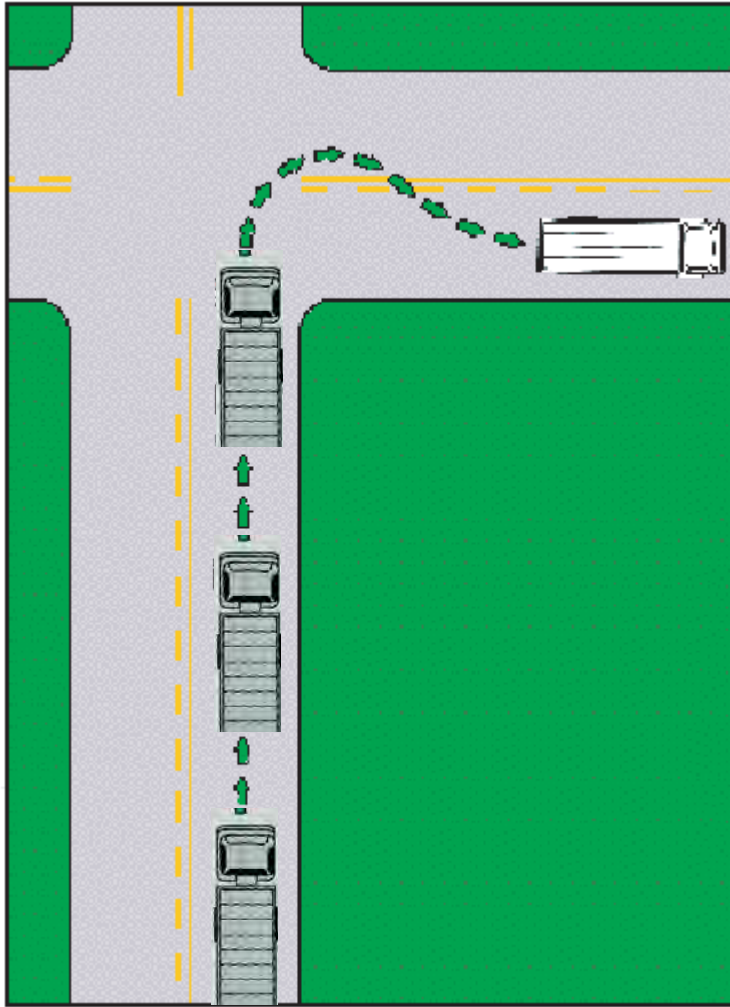

This illustration shows the correct procedure for making a right turn with a single-unit vehicle.

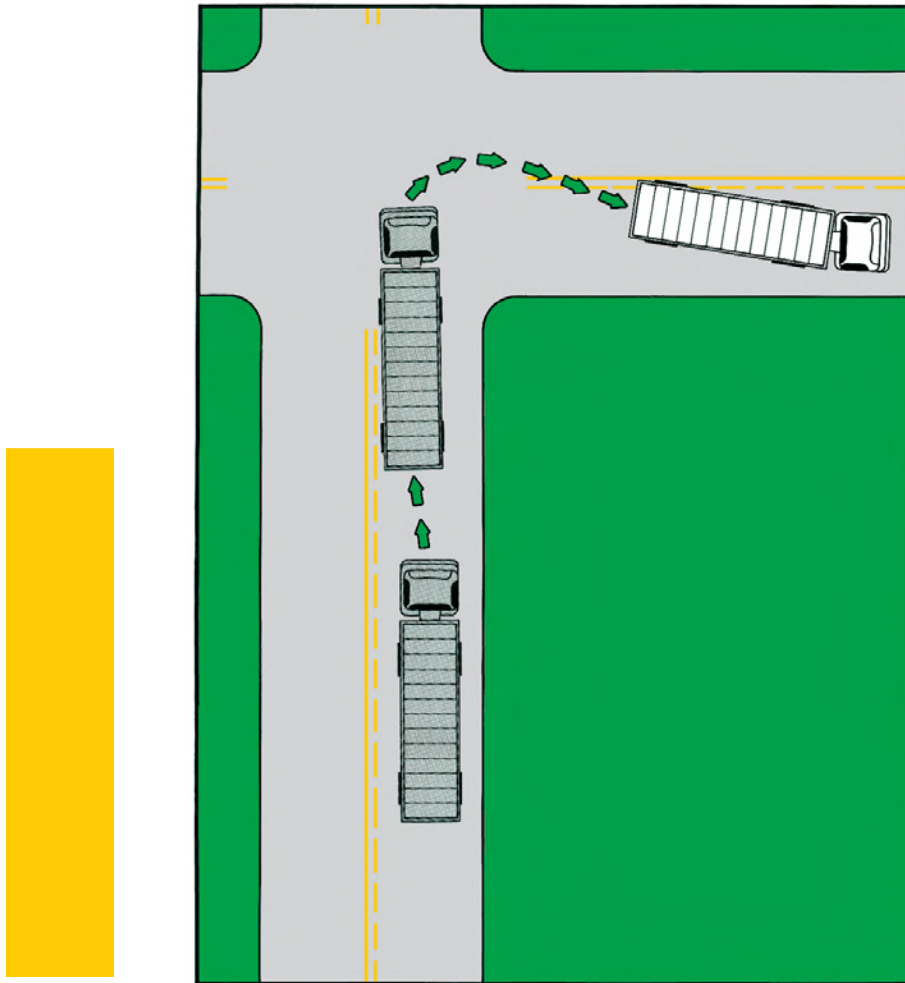

116

This illustration shows how to make a right turn with a tractor semi-trailer. If the turn is sharp or difficult, swing out into the street you're about to enter. Watch the off-track to avoid running over the curb.

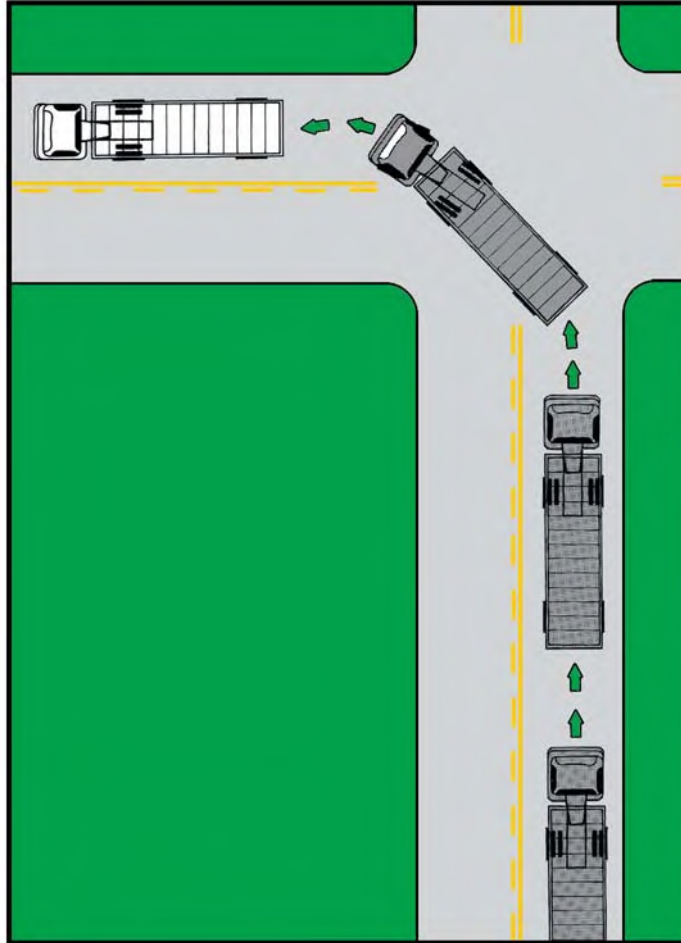

This illustration is the correct procedure for making a left turn with a tractor semi-trailer. The procedure is the same with a single-unit vehicle.

Left Turns

Slow down when making a left turn. You must get into the lane nearest the center line. Make sure no one is attempting to pass you. Look for traffic approaching toward you, and to the left and right. Your vehicle should be just to the right of the center line as you make your left turn. Watch your off-track while you are turning.

Backing

A major difficulty for many truck drivers is backing correctly. You must back without interfering with other traffic.

It's a good idea to park safely and walk back to inspect your proposed backing route. Use your outside mirrors and, if possible, have someone stand to the right rear side of the truck while backing to give you directions and assure that you're backing safely. Remember that you are responsible for safe backing, even with a helper.

1. Steering (backing): On a single-unit, you must steer the single-unit vehicle in the direction in which you wish to move the back end of the vehicle.
2. Steering (backing): A combination vehicle will steer opposite to the intended direction to turn the rear of the trailer. The rear axle of the tractor acts as the front axle of the semitrailer and, in effect, steers the semitrailer. The tractor must follow an "S-shaped" course.

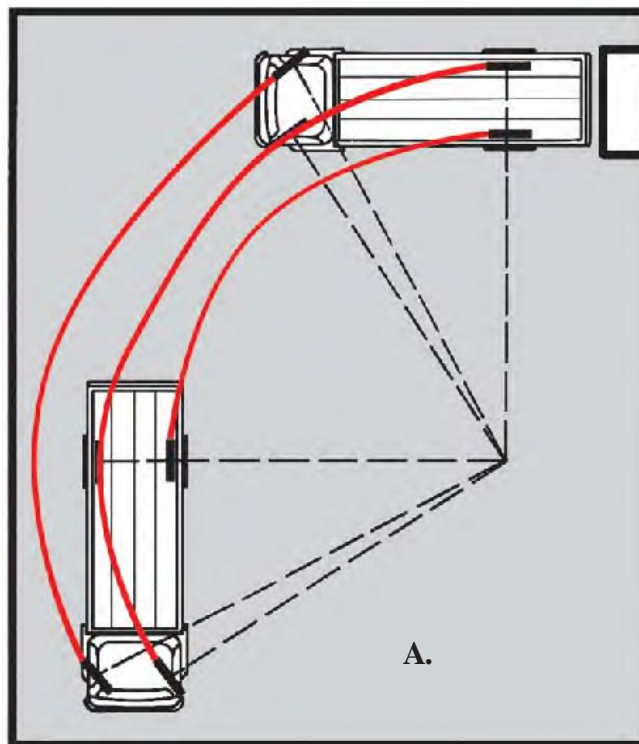

A. Steering (backing) with a single-unit vehicle



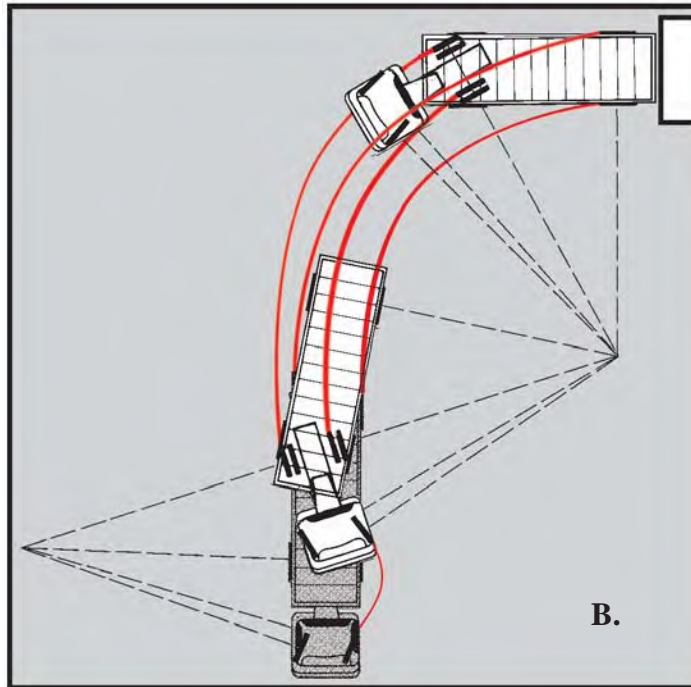

B.

B. Steering (backing) with a tractor semi-trailer

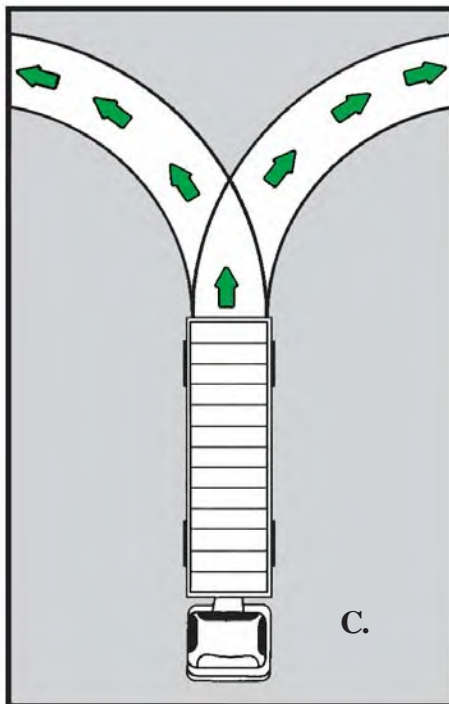

C.

C. Blind side - View side
When driving a semi-trailer, or single unit trucks, you can back safely on your own. But if you're backing to the blind side, have someone outside to guide you. When backing, have someone to guide you when possible.



Hooking-Up/Unhooking Requirements

The procedure for hooking-up and unhooking tractor semitrailer combinations follows:

Coupling:

1. Be sure the jaws of the fifth wheel (coupling device) are fully opened and the fifth-wheel is tilted back so that the hookup can be made without damage. Back slowly and as straight as possible.
2. Line up the kingpin with the fifth-wheel slot. Be certain trailer heights are correct. Back straight and slow.
3. Stop the tractor just as the fifth-wheel makes contact with the trailer.
4. Secure the tractor and check to see if the trailer is secured against movement.
5. Connect the brake lines and electrical connections.
6. Check the trailer brakes with the hand valve and reopen the valve for backing.
7. Back under the trailer without rolling forward.
8. Check the coupling by pulling the tractor forward.
9. Secure the tractor and release the hand valve.
10. Check the coupling from underneath the trailer.
11. Raise the trailer supports and secure the handle in the low-range position.

Uncoupling:

1. Secure the tractor and block the semitrailer, if necessary.
2. Place the tractor protection valve in the emergency position.
3. Lower the trailer supports and secure the handle.
4. Disconnect the emergency air line first.
5. Disconnect the electrical connector and the service air lines.
6. Pull the fifth-wheel hook and lock handle.
7. Pull ahead gradually to allow the trailer landing gear to take up the load gradually.
8. Secure the tractor and check the trailer supports.

Trailers left parked should have the wheels chocked to prevent a roll-away. Air pressure in the trailer air tank will bleed down in proportion to the amount of leakage in the trailer system. If the trailer tank is drained, the trailer brakes will release.

If the trailer is equipped with “spring brakes,” the brakes will remain in the applied position when the air pressure in the system is released.

Always take time to insure that your vehicle is properly coupled. By following the proper procedures and making frequent safety checks, you can greatly lessen the chances of a breakaway.



Specific Maneuvers Required During the Test

The examiner will ask you to perform certain driving maneuvers, including:

The Stop Line

To test your ability to judge the position of the front bumper with respect to a fixed line. This maneuver simulates the conditions encountered in stopping at a marked crosswalk, or a situation in which the driver must pull forward as far as possible in close quarters without touching a stationary object or vehicle.

Straight Line Backing

To test your ability to keep the truck under control while moving backward with the use of mirrors. When backing a combination unit, keep the left rear corner of the trailer in sight at all times. The vehicle must be backed slowly, smoothly and as straight as possible.

The Serpentine

To test your ability to maneuver your vehicle in and out of tight places. This maneuver simulates conditions that might be encountered when disabled or wrecked vehicles partially block the highway, or in negotiating detours in heavy traffic or other situations.

Alley Docking

To test your ability to back your vehicle into a narrow space and stop with the rear of the vehicle within a specified distance of the back limits of the space. This would be similar to backing up to a dock or shipping platform between two other vehicles from a street or yard area with limited space.

Backing and Alley Docking: Special Situations, Extra Precautions

If you are operating a bus, a vehicle with extra width or length or a vehicle carrying a heavy load, you have special responsibilities and must take extra precautions.

1. Buses may create hazards when dropping off or loading passengers, as well as when moving in and out of traffic. Therefore, as a bus driver, responsible for other people, you must be constantly alert.
2. Because of their width, single-unit vehicles have a blind spot of 50 feet or more directly behind them. Be careful when shifting lanes or turning to avoid hitting other vehicles.

Off-street
maneuvers

Total length 250 feet
Width 50 feet
Alley width 12 feet
Alley length 25 feet



122

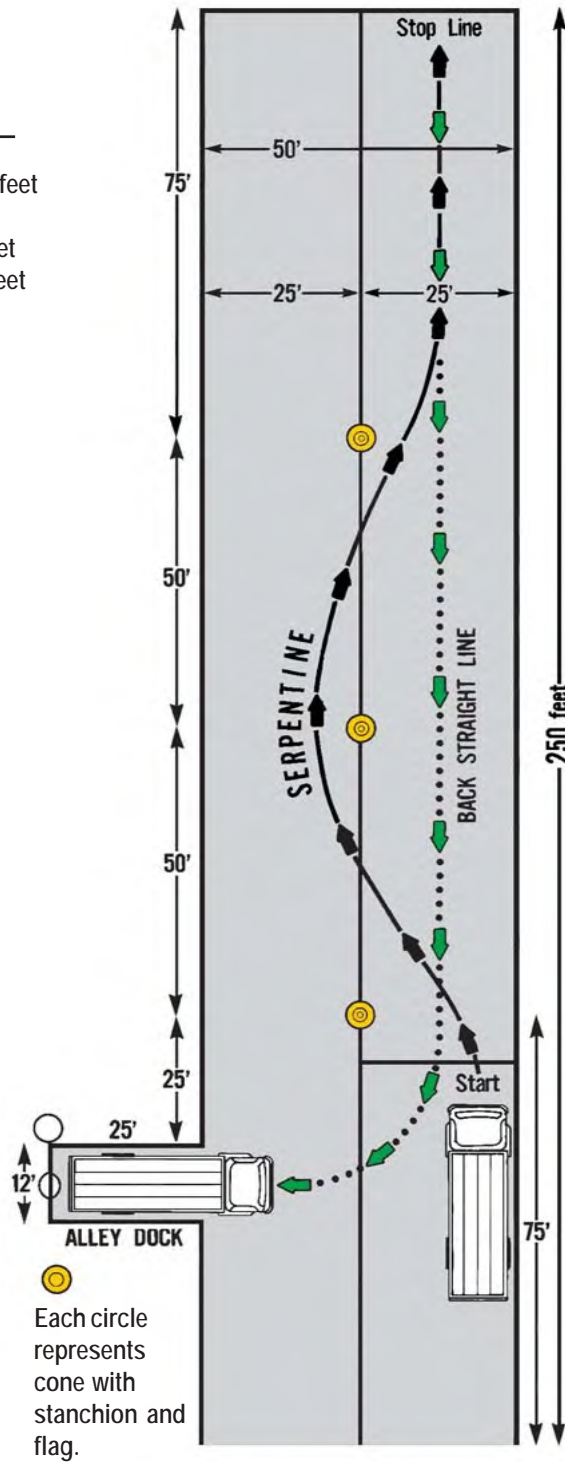

3. Single-unit and double-unit vehicles with a load extending over the maximum length must have a special permit, and a red flag must be attached at the end of the load.
4. A driver must always be aware of the possibility of loads shifting and take the necessary action to prevent this from occurring. Drivers should not operate a vehicle when cargo is not properly balanced and secured.
5. Vehicles with heavy loads often create a traffic hazard when entering a street or highway because they must enter so slowly. Be sure you have sufficient time to move into the line of approaching traffic and give the necessary signal.
6. When approaching an overpass you should be sure there is enough clearance between the vehicle and the overpass.
7. On a short entrance to an interstate when your vehicle is heavily loaded you must look for enough space in traffic to allow for a smooth entrance onto the interstate.

When approaching a green traffic light, you should be alert and prepared to make a smooth stop.

Stopping And Parking

1. Stopping or parking on the open highway should be avoided. Stopping on the shoulder area of a high-speed limited-access highway is particularly dangerous and, except in cases of emergency, is prohibited by law. Never stop just over the crest of a hill or on a curve.
2. When it is necessary to park outside a business or residential district, pull your unit as far to the right, off the traveled portion of the roadway, as is safely possible. You should never leave your truck parked without making sure it cannot be moved.

State law requires that you move your vehicle clear of the traveled portion of the roadway to allow free passage of other vehicles.

Parking

Never park your vehicle in a position where it obscures another driver's view as he attempts to enter a street or highway from a driveway, truck stop or other place.

A. Proper Parking

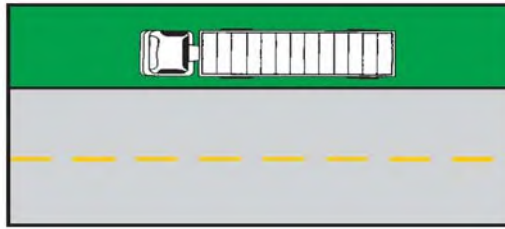

B. Improper Parking

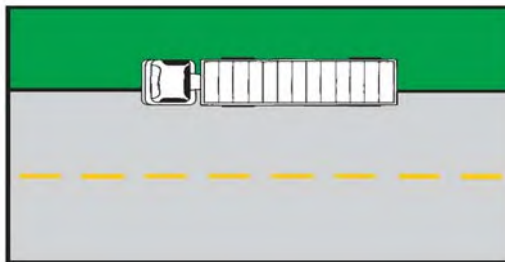

Even when stopping for emergencies, pull your vehicle safely as far off the roadway as possible. On interstates or other limited access highways, use the emergency parking lane (keeping your vehicle entirely off the main roadway).

C. Three Ways of Parking

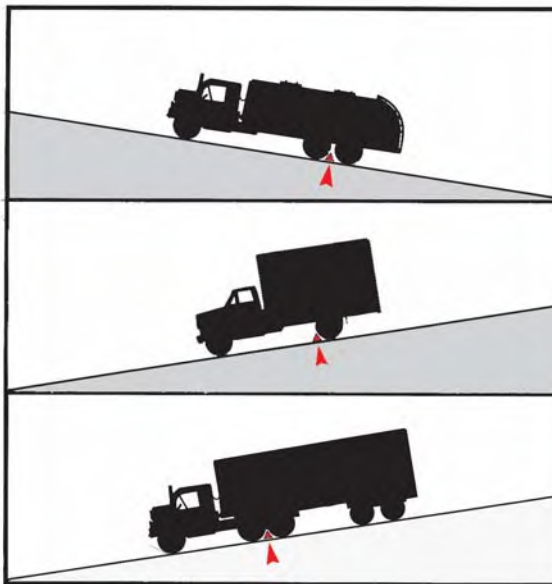

When parking on a hill, use chock blocks to reduce the chances of a runaway vehicle. Recommended placement of blocks indicated in red.



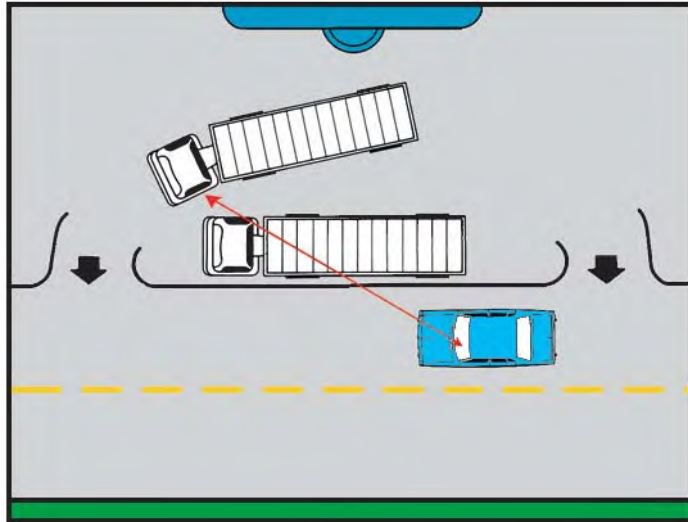

Unsafe Parking

Never park your vehicle in such a way that it blocks another driver's view as he attempts to enter a street or highway from a driveway, truck stop or other place.

Emergency Stops And Warning Signals

When your vehicle is disabled and you cannot move it off the traveled portion of the roadway, you must put out emergency signals as shown on the next page.

Emergency warning signals may be red flags, pot torches, reflector flares, reflective triangles, red electric lanterns or fuses.

When necessary to stop in the daytime, put out red flags or reflective triangles as follows:

1. Place a warning device at least 100 feet but not more than 500 feet in the center of the lane, both in front of and behind the stopped vehicle.
2. On a divided highway or one-way roadway, place one warning device at least 200 feet to the rear of the stopped vehicle and one at a distance of 100 feet to the rear, in the center of the lane.

When visibility is restricted to less than 500 feet due to fog or similar conditions, use the signals specified for night use.

When necessary to stop at night, immediately turn on your four-way flasher to make the turn signals on both sides of your vehicle flash simultaneously at the front and rear and then place reflective triangles, reflective flares, red electric lanterns or fuses as follows:

1. On a straightway, place one warning device on the traffic side, 10 feet to the rear of the vehicle.

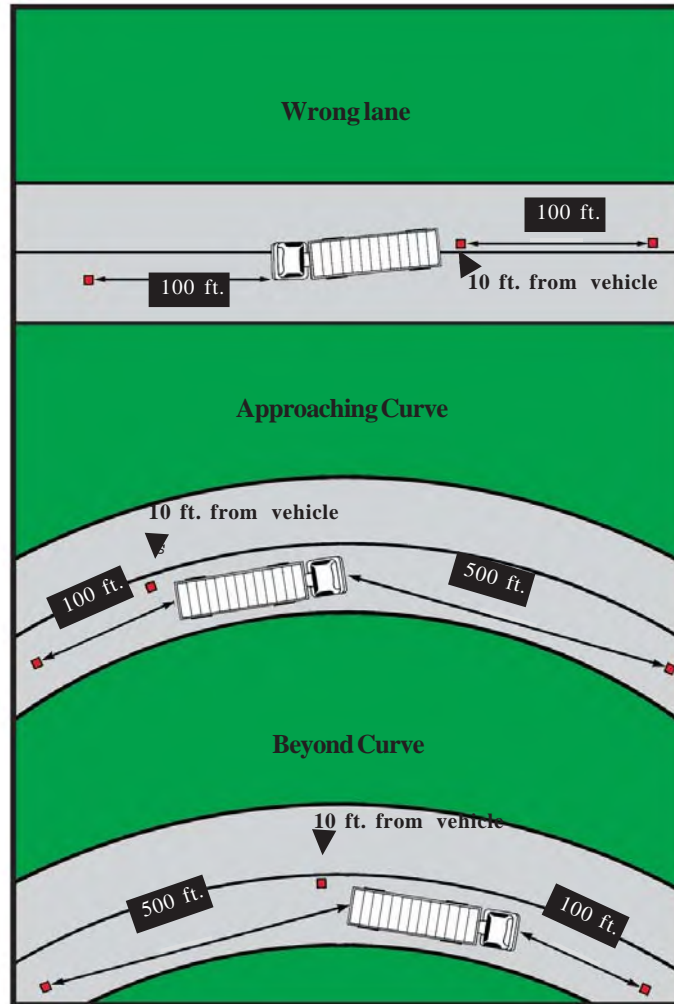

126

Correct placement of warning devices when you are forced to stop your vehicle in an emergency may mean saving your life or the life of another motorist.

2. Next, a warning device at least 100 feet behind the stopped vehicle, in the center of the lane.
3. Another warning device 100 feet ahead of the stopped vehicle, in the center of the lane.
4. One additional warning device, if available, on the traffic side, 10 feet from the front of the vehicle.
5. On a divided highway or one-way roadway, one signal 200 feet and one 100 feet to the rear, in the center of the lane, and one at the traffic side of the vehicle 10 feet to the rear.

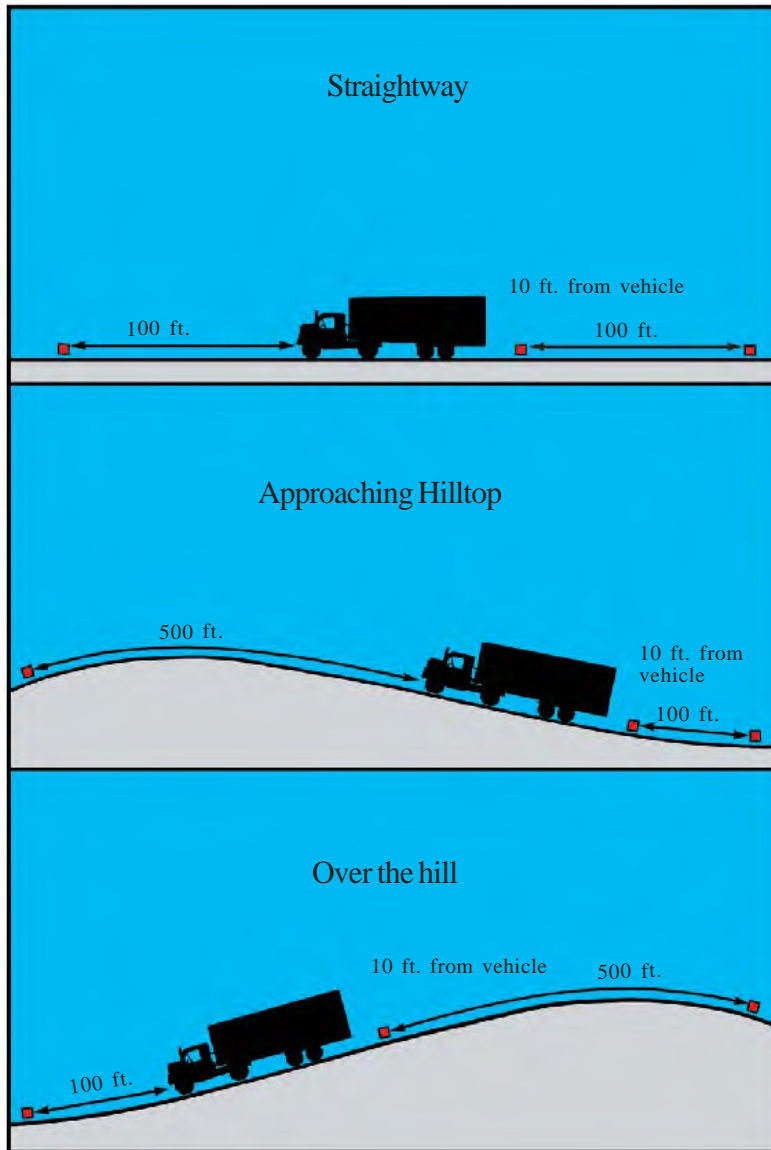

Whenever the view of your stopped vehicle and warning signals is blocked by the crest of a hill, a curve or other obstruction, the warning signal closest to the obstruction to view shall be set at least 100 feet but not more than 500 feet from your vehicle.

Fuses Can Be Dangerous

1. Fuses can cause bad burns. When lighting them, hold the lighted end well away from your body, particularly your face and eyes.
2. Never attach a flame-producing warning signal to any part of your vehicle. It is both dangerous and against the law.
3. In the event of spillage or leakage of fuel, use flame-producing warning signals with caution. Be sure they are placed far enough away from your vehicle to avoid a fire.
4. Avoid the use of flame-producing warning devices on the cargo tanks transporting flammable liquids or flammable compressed gases, or vehicles transporting Explosives, Class A or Class B, or on any vehicle using compressed gas as a fuel.

Use Of Four-Way Flasher

The use of a four-way flasher is recommended as follows:

1. At any temporary stop in a business, residential or open country area when the sight distance is restricted to less than 500 feet and the vehicle cannot be moved clear of the roadway.
2. When parked momentarily in a business area to load or unload freight.
3. Where there is a disabled vehicle, until necessary warning devices are put out.
4. When vehicles are carrying passengers or hauling explosives or flammable materials, and making mandatory stops at railroad grade crossings.
5. In any other situation whenever the vehicle has to be stopped or parked temporarily in a traffic lane or adjacent to a traffic lane.



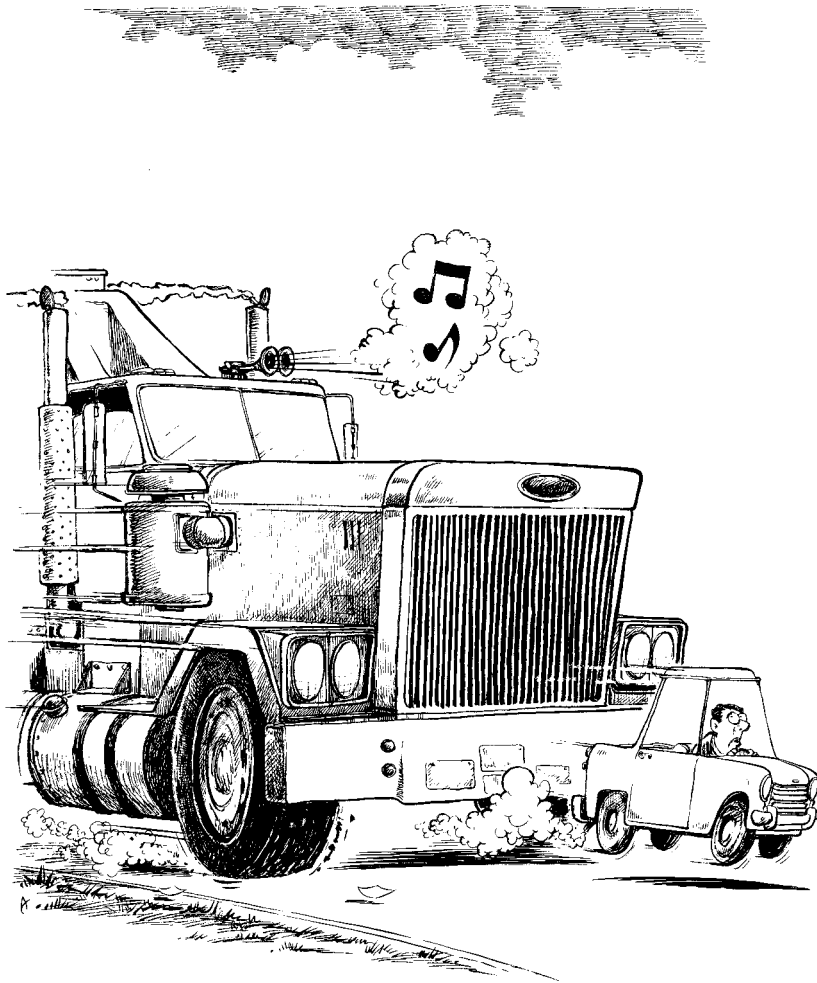

Remember you're bigger than they are. Show respect for other vehicles on the road by leaving appropriate space between you and other vehicles.



Motorcycles



MOTORCYCLES

The information in this section is for two-wheeled motorcycles only. To get a permit or license for a three-wheeled motorcycle or a motorcycle with a side car, refer to the three-wheeled motorcycle handbook.

How To Get License/Permit

To get your permit you must be at least 15 years old and take a knowledge test at one of SCDMV's driver license examining offices.

Rules that cover driver permits for other vehicles also apply to you, except that you may not operate a motorcycle, motor scooter or light motor driven cycle from midnight to 6 a.m. with a beginner's permit unless you are accompanied by a Class M licensed parent or guardian. If you are 15 or 16 years of age, you must also pass a driver's education course before you apply for your motorcycle license. Courses offered by the Motorcycle Safety Foundation do not meet the driver's education requirement.

Your knowledge test consists of multiple-choice questions with three or four possible answers, only one of which is correct. You will need to study all of the material in this guide (except the section for truck drivers) in order to pass the test.

After you have had your permit at least 180 days, you may take the motorcycle skills test.

Getting to Know Your Motorcycle

132

Know Your Vehicle And Its Controls

In order to become a safe operator, you must learn the location and smooth operation of the motorcycle's controls. Most two-wheel motor vehicles have standard controls located at about the same places on all models.

The accelerator is controlled with the right handgrip, the rear brake is operated with one foot, usually the right, and the opposite foot operates the gearshift. The lever on the right handlebar operates the front wheel brake. The clutch control is located on the left handlebar. This location eliminates the necessity for removing the hand from the grip. Make sure your clutch lever is at a right angle from your wrist. Having to reach up or down for a lever is not only unsafe, it is much more tiring to the operator.

How To Accelerate

A beginner who twists on a large handful of throttle and lets the clutch out too abruptly will find his speed very difficult to manage. Most motorcycles have enough power to start the back wheel spinning violently under these conditions. Practice rolling on the throttle gently and smoothly while letting out the clutch the same way. The mark of a veteran rider is his ability to ease off from a stop quietly and smoothly.

Learn To Shift Smoothly

If your motorcycle is equipped with a foot-lever type gearshift, as most motorcycles now are, smooth shifting is not difficult. It is possible to go through the gears quickly and quietly. The experienced rider can shift into a higher or lower gear at will without grating noises coming from the gearbox. Decelerate just before downshifting when approaching a traffic signal or a stop sign, and at other places where you are required to come to a stop.

Brake

Use both brakes every time you slow or stop. Using both brakes for even “normal” stops will permit you to develop the proper habit or skill of using both brakes properly in an emergency. Squeeze the front brake and press down on the rear. Grabbing at the front brake or jamming down on the rear can cause the brakes to lock, resulting in control problems.

Steering The Motorcycle

You must demonstrate proficiency in turning and handling a motorcycle before you can be licensed to operate one.

You must constantly allow for such hazards as loose sand, pebbles, mud, moisture or wet leaves on the pavement, as well as the oil slick in the middle of the travel lane. In winter allow for ice and snow. All of these factors can cause the wheels to slide from under you. Following are some safety tips for the motorcyclist:

1. Slow to a safe speed before turning.
2. Lean in the direction you wish to go, turning slightly. Handlebars will turn almost by themselves with no apparent effort on your part. Learn through practice the correct amount of lean. (A passenger should lean with the driver.)
3. Avoid dragging your feet on the roadway by keeping them on the footrests except in emergencies. A quick stab with the foot can sometimes correct a skid, but this is a tricky business and should be done with great caution.

Railroad Tracks

You don't have to cross railroad tracks head-on (at a 90 degree angle). Usually, it's safer to take the tracks as they come, riding straight within your lane. A motorcycle can cross tracks at an angle as sharp as 45 degrees without difficulty. Changing your course to take tracks head-on can be more dangerous than crossing at an angle, which may carry you into another lane of traffic. Slow down and check conditions carefully before crossing.

You do need to change direction, however, to cross something that runs in the same direction you are going. For example, you may wish to cross trolley tracks, ruts in the middle of the road, or pavement seams that run parallel to your course.

To cross these tracks safely, move far enough away to be able to cross them at an angle of a least 45 degrees. Then, make a quick, sharp turn across. Do not try to edge across. The tracks or a seam could catch your tires and throw you off balance.

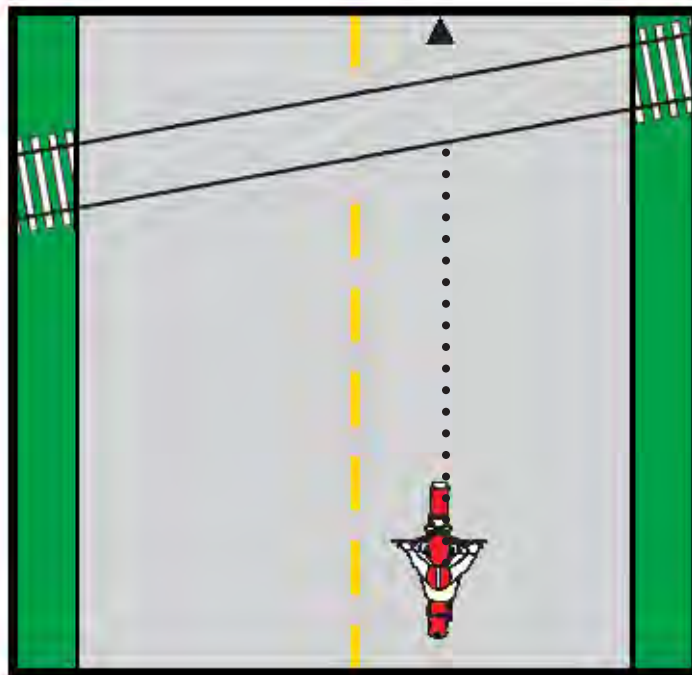

Cross tracks with caution, riding straight within your lane.

Preparing to Ride: Protective Clothing

Protective clothing is necessary for safe riding.

The smart rider wears: Clothing that covers the entire body. Heavier material furnishes the most protection. Brightly-colored materials will make it easier for other motorists to see you. A long-sleeved shirt or jersey, or a leather jacket can be protective in case of a fall. Long pants, especially heavy denim, and full finger gloves are also good protection.

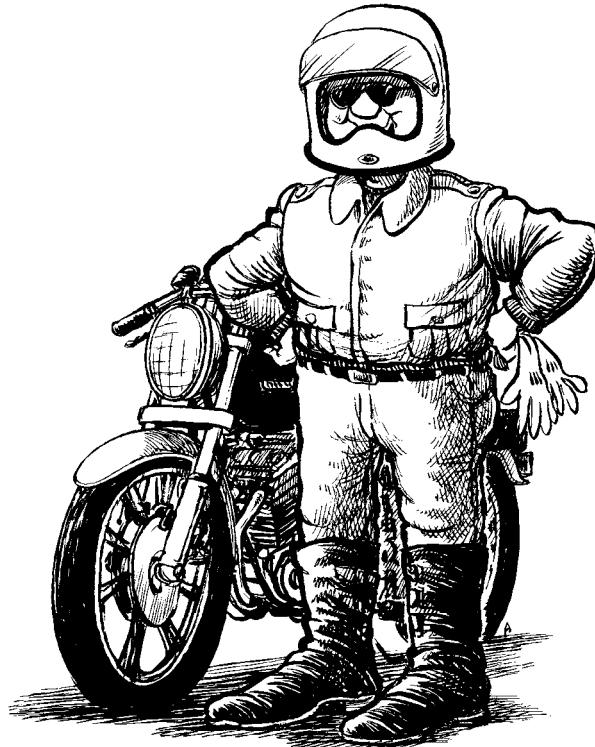

When riding a cycle of any kind, dress for the occasion – for safety and your life.

Proper Footwear

Laced up boots are best, but high-top boots or heavy shoes that support your ankles are fine. Never ride barefooted.

Riding around in light clothing and without proper shoes may look sporty, but if you have to leave the bike in a hurry there's nothing to protect you between your body and the surface on which you are traveling.

Protective Helmet

South Carolina law requires motorcycle operators and passengers under 21 years of age to wear approved motorcycle helmets at all times while they are riding a motorcycle.

Statistics prove that most motorcycle fatalities are the result of head injuries received in accidents. Properly constructed helmets provide a high degree of protection from the fractures, abrasions and other injuries which are so common to the victims of motorcycle accidents.



In South Carolina, drivers and passengers under the age of 21 are required by law to wear a helmet and eye protection while riding.

Eye Protection

State law requires operators under 21 years of age to provide themselves with some acceptable type of eye protection while riding. This may be in the form of face shields attached to helmets or goggles. Dark, off-colored protection should be worn on bright days, but should be avoided at night because the rider needs all available light to see the road ahead, and colored shields or lenses reduce the amount of light reaching the eyes.

Flying insects and dirt which are not diverted by proper eye protection devices may not only cause damage to the eyes but may also lead to temporary loss of control and thereby to accidents.



You Have Chosen A Motorcycle

You have chosen a motorcycle, either for recreation or useful transportation.

If you are just learning, choose a well-qualified instructor, preferably a mature person with several years of experience in operating a motorcycle.

Where you practice is important; it should be removed from traffic congestion and other distractions. Learn to ride on a paved surface rather than an unpaved surface.

Many learners easily master the fundamentals of riding. On the modern lightweight machines, balance is relatively simple. The bike will almost balance itself.

You should always have the proper size of motorcycle for your size and weight, recognize its limitations, and keep the cycle in good repair. Proper inspection and maintenance are important. You will enjoy the use of your motorcycle much more and in greater safety if it operates dependably.

Getting Comfortable On The Motorcycle

You must be comfortable on your motorcycle in order to operate it safely. Enjoyment of your ride is increased by having the various components of the cycle fit you.

Handlebars may be adjusted forward or back and different style handlebars permit higher or lower grip. As a general rule, short, low bars are recommended for average driving. In some cases, motorcycle saddles can be positioned differently for greater comfort and convenience in riding.

Position the gear lever where you can operate it easily with your toe. Make sure the clutch and brake levers are located on the bars in positions that are comfortable for you.

Make certain the transmission is in neutral before starting the engine. Most motorcycles have a neutral indicator on the speedometer which lights when the ignition switch is on and the cycle is in neutral. Make sure the fuel petcock is turned to the “on” position. The petcock is usually on the bottom of the gasoline tank.

Depress the kick starter as you turn on the throttle about halfway. Don't be afraid to kick, using your full body weight. Practice operating the controls while the cycle is on the stand. Do this until you become familiar with the controls, or until you automatically know where each control is. This is essential to you in preventing or avoiding accidents.

If you are trying out a strange motorcycle, don't attempt to ride it until someone has gone over the controls with you. They are generally similar on most models, but you need to know for certain. Check the brakes shortly after placing the motorcycle in motion.

Defensive Attitudes Aid Survival

In motorcycling, as in automobile driving, you must drive defensively to keep from having an accident.

The cyclist's attitude toward driving plays a large role in his safety record. That is, developing a defensive attitude toward other traffic makes you a more alert and prepared rider.

You must never assume the other driver will give you the right-of-way. If you have any doubt about who has the right-of-way, you should always yield. Remember, a motorcycle is no match for an automobile or truck if there is a collision. Always assume that other motorists will do the unexpected.



Do not assume other vehicles are watching for you. Be prepared to yield right-of-way when approaching vehicles, particularly at intersections and signals.

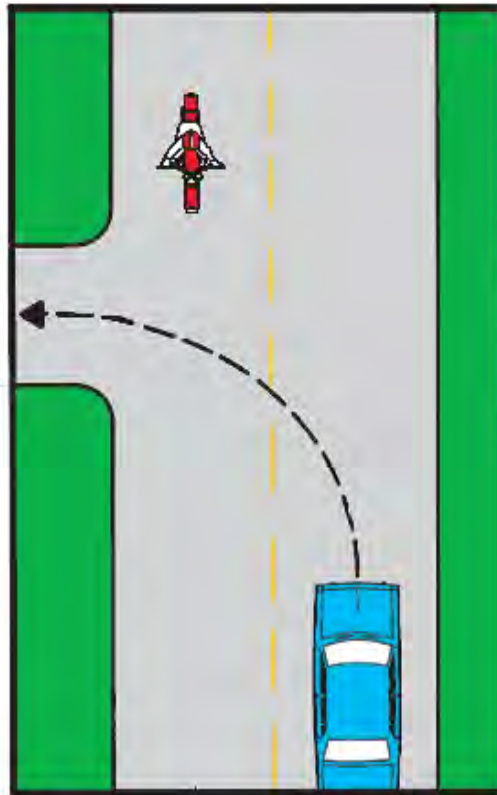

Motorcycle Safety

This manual cannot teach you how to control direction, speed, or balance. That's something you can learn only through practice. However, here are a few pointers to help you keep control and avoid accidents.

When you travel on major streets with stop signs for crossing traffic, don't assume that vehicles on those streets will stop. For your own protection, slow down and prepare to stop in case other vehicles don't.

When you are angry or upset, you are a good candidate for an accident, which the motorcyclist can never win. Never ride when you are tired or sleepy.

Seeing And Being Seen

While it's most important to keep track of what's happening ahead, you can't afford to ignore what's happening behind.

Traffic conditions can change quickly. By checking your mirrors every few seconds, you can keep track of the situation.

Knowing what's going on behind you can help you make a safe decision about how to handle trouble ahead. For instance, if you know someone is following you too closely, you may decide to avoid a problem ahead by turning away from it, rather than by trying to stop quickly and risk being hit by the tailgater.

Frequent mirror checks should be part of your normal scanning routine. Make a special point of using your mirrors in these situations:

- When you are stopped at an intersection. Watch cars coming up from behind. If the driver isn't paying attention, he could be right on top of you before he sees you.
- Anytime you plan to change lanes. Make sure no one is about to pass you.
- Anytime you slow down, it is especially important to check the driver behind you. He may not expect you to slow down, or he may be unsure about exactly where you will slow down. For example, he might see you signal a turn and think you plan to slow for a turn at a distant intersection, rather than at a nearer driveway.

Many motorcycles have rounded "convex" mirrors. These give you a wider view of the road behind you than do flat mirrors. However, they also make cars seem farther away than they really are. If you are not used to convex mirrors, get familiar with them before you ride.

Here's how: While you are stopped, pick out a parked car in your mirror. Try to form a mental image of how far away it is. Then, turn around and look at it. See how close you came. Practice with your mirrors until you become a good judge of distance. Even then, allow extra distance before you change lanes.

Head Checks

Mirrors do a pretty good job of letting you see what is behind you. But motorcycles have "blind spots" just like cars. Before you change lanes or enter a lane of traffic, make sure to make a head check: turn your head, and look at traffic to the side. This is the only way you can be sure of spotting a car just about to pass you.

On a road with several lanes, check the far lane as well as the one next to you. A driver in the distant lane may be headed for the same space you plan to take.

Body Position

To control a motorcycle well, your body must be in the proper position.

- **Seat**-Sit far enough forward so that your arms are slightly bent when you hold the handle grips. Bending your arms lets you turn the handlebars without having to stretch.
- **Hands**-Hold the handle grips firmly. This will help you keep your grip if the motorcycle bounces. Start with your right wrist down. This will help you keep from accidentally using too much throttle- especially if you need to reach for the brake suddenly.
- **Knees**-Keep your knees against the gas tank. This will help you keep your balance as the motorcycle turns.
- **Feet**-Keep your feet firmly on the foot pegs. Firm footing can help you keep your balance. Don't drag your foot along the ground. If your foot catches on something, you could lose control of the motorcycle.

Rearview Mirror

South Carolina law requires every motorcycle to be equipped with at least one rearview mirror. It is almost as important for a motorcyclist to know what is behind him as it is to know what is ahead. Since a look to the rear at the wrong time could easily contribute to an accident, the rearview mirror is the safest method of keeping tabs on what is behind you. A good practice to follow is to use the mirror often, and to verify what you see in the mirror from time to time by turning to look back when it is safe to do so.



Your Position In Highway Lane

The motorcyclist may choose whether to ride near the right edge of a two-lane highway, in the center of the lane or nearer to the center line. Generally, however, it is best to avoid the direct center of the lane because that's where oil drippings from other vehicles have coated the pavement. In the event of rain or the need for an emergency stop, the motorcycle's tires will have less traction there. Also, avoid painted lines on pavement when they are wet, as they are more slippery than when they are dry.

When following an automobile or truck, the motorcyclist's line of sight is greatly reduced if he is directly behind the vehicle ahead. By riding to the left side of the lane, he will have a better chance to avoid a rear-end collision with the vehicle if it should stop unexpectedly. Also, the leading driver will be able to see the motorcyclist in his outside rearview mirror if the motorcycle is riding to the left side of the lane.

If the vehicle immediately in front of a motorcycle rider stops suddenly, the motorcyclist should apply his brakes and steer to the right or left side. Try to stay in your lane.

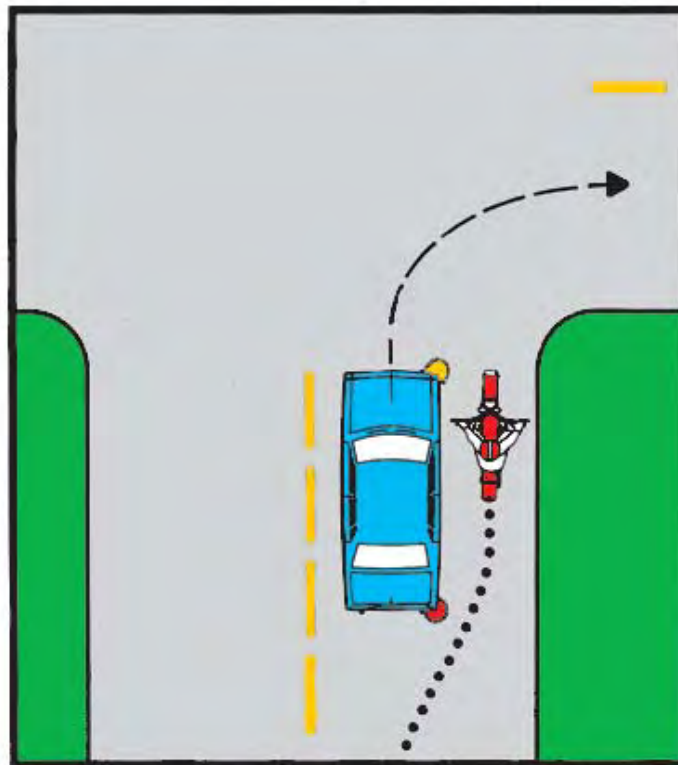

Don't create your own lane. It's dangerous and it's illegal.

Use Of Headlights

State law requires that all persons operating motorcycles or motor-driven cycles on public streets and highways have the headlight of the motorcycles turned on at all times when the vehicles are in use. Automobile drivers can see a lighted headlight in an oncoming traffic lane long before they are able to recognize a motorcycle and its rider. The use of headlights also makes motorcyclists more noticeable to drivers traveling in the same direction. They are less likely to pull out into a traffic lane occupied by a motorcycle in order to pass some other vehicle.

How To Avoid Trouble

The biggest dangers facing you as a rider are (1) oncoming cars that turn left in front of you, and (2) cars on side streets that pull out into your lane. Never count on “eye contact” as a sign that a driver has seen you and will yield the right of way. All too often, a driver looks right at a motorcyclist and still fails to see him.

The only eyes you can really count on are your own. The best way to avoid trouble is to see it coming as soon as possible. Experienced riders make a practice of looking far ahead. On city streets, they scan the road from one-half to a full block ahead. On the highway, they look as far ahead as they can see clearly.

Experienced riders don't just “stare off into space.” They keep track of what's happening right ahead of them as well.

By looking far as well as near, they get a complete picture of the situation ahead and leave themselves plenty of time to adjust to problems. Thus, they can spot and handle trouble without having to make a panic stop or a sudden swerve that can cause an accident.

Here's what to look for while scanning the road ahead:

- **Road Conditions**-Keep checking the road surface ahead for slippery spots, bad bumps, broken pavement, loose gravel, wet leaves or objects in your path.
- **Traffic Conditions**-When there is a car directly in front of you, look over or through the car for traffic stopping or turning further down the road. Check the roadside for cars that may pull away from the curb or cut into your lane from side streets or driveways.
- **Escape Routes**-Look for open space where you can leave the road in a hurry if you have to. Scanning the road and roadside for escape spots is most important when you are riding in heavy traffic.



Get in a Position To See

As a motorcycle rider, you can put yourself in a position to see things that a car driver cannot see.

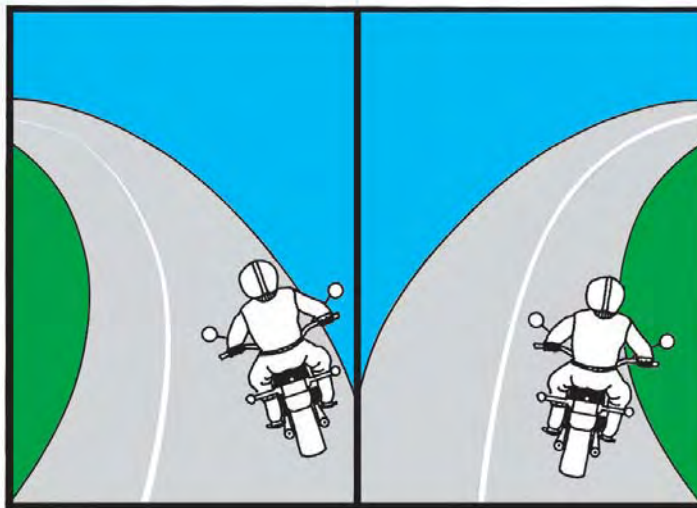

Moving to the right portion of your lane before a left-hand curve, and staying on that side until you come out of the curve, allows you to spot oncoming traffic. On right-hand curves, a left center position is best. This allows you to see, and be seen, better.

- **On Curves**-You can move from one portion of a lane to another to get a better view through a curve. Moving to the right portion of your lane before a lefthand curve and staying on that side until you come out of the curve lets you spot traffic coming toward you as soon as possible. On righthand curves, a left center position is best. It lets you see oncoming cars early without putting you so far left that you run the danger of being hit by a car that tries to “cut” the curve by drifting into your lane.
- **At Blind Intersections**-An intersection is anywhere a driveway, alley, or road meets another road. Blind intersections can make it hard to see danger coming from the side. If you have a stop sign, stop there first. Then edge forward and stop again, just short of where the cross-traffic lane meets your lane. From that position, you can lean your body forward and look around buildings, parked cars, or bushes to see if anything is coming. Just make sure your front wheel stays out of the cross lane of travel while you’re looking.



- **At The Roadside**-Angle your motorcycle so that you can see in both directions without straining and without having any part of the cycle in the lane of travel. Angling your motorcycle so that you can get a clear view in both directions is particularly important if you plan to turn across a lane of traffic.

When Vehicles Turn Left

One of the major causes of accidents involving motorcycles is when automobiles or other vehicles turning left into a driveway, parking lot, or side street disregard an oncoming motorcycle.

You, as a motorcyclist, must be alert to avoid this situation. Watch every vehicle approaching you and look for signs the driver is turning without having seen you. Ease off the throttle and be ready to stop quickly or turn defensively if necessary. Also, watch carefully if you are attempting to pass a vehicle that may turn left and push you into opposing traffic. Watch for roadsides, driveways or other places that might require you to be especially careful.

Trouble At Stop Signs

Never take for granted that a vehicle will stop for a stop sign just because it's there. Many don't and hundreds of accidents occur every year as a result.

Don't get caught in the middle. You should always keep a safe distance between yourself and the vehicles in front of and behind you.

Try to regulate the distance between yourself and the vehicle behind you. If the vehicle following you insists on tailgating, your best bet is to pull over when it is safe to do so and let the vehicle pass.

Your vision is greatly reduced when you are following other vehicles too closely. By riding too closely to them, you may fail to see an object or condition in the road ahead, and may strike a hole or debris in the roadway as a result. You should never be closer than the distance it will take to stop if the vehicle you are following stops suddenly.

Group Riding

The proper formation for group motorcycle riding is a staggered pattern. This way, cyclists can be more easily seen by motorists approaching from the opposite direction.

If you are riding in a group at night, a staggered pattern lessens the chances that you will be mistaken for an automobile by approaching motorists.

Side-by-side riding should be avoided, because it reduces the space for maneuvering available to each operator. When traveling in a group in the staggered formation, each cyclist should be careful to maintain the proper following distance at all times.



Staggered Formation-Riding in a “staggered” formation is the best way to keep ranks close and yet maintain an adequate space cushion. In a staggered formation, the leader rides to the left side of the lane, while the second rider stays a little behind and rides to the right side of the lane. A third rider would take the left position. The fourth rider would be a normal position behind the second rider. (See visual aid.) This formation keeps the group close and keeps each rider safe distance from others ahead, behind and to the sides.

A staggered formation can be used safely on an open highway. However, it is best to move into a single-file formation when taking curves, making turns, or entering or leaving a highway.

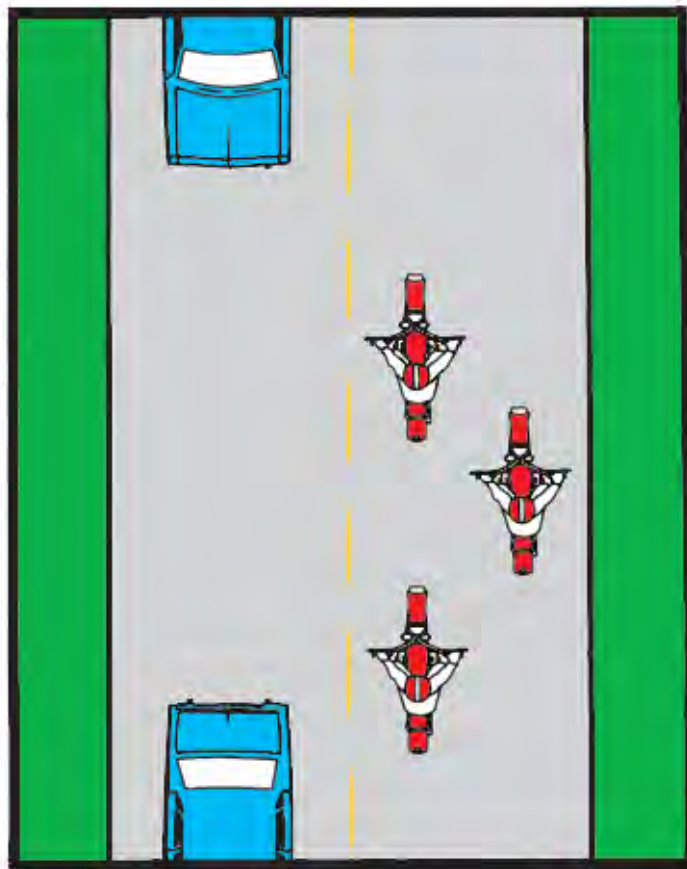

Avoid riding side-by-side. Use the staggered formation when traveling in a group.

Passing In Formation-When riders in a staggered formation want to pass, they should do it one at a time. First, the lead rider should pull out and pass when it is safe. After passing, the leader should return to the left position and keep up to passing speed until he has opened up room for the next rider. As soon as the first rider has passed safely, the second rider should move up to the left position and watch for a safe chance to pass. After passing, this rider should return to the right position and open up room for the next rider.

Some people suggest that the leader should move to the right side after passing a vehicle. This is not a good idea. By taking up a right-side lane position, the leader would encourage the second rider to pass and cut back in before a large enough cushion of space has been opened up in front of the passed vehicle. It's safer if each rider waits until there is enough room ahead of the passed vehicle to allow the rider to move into the same position held before the pass.

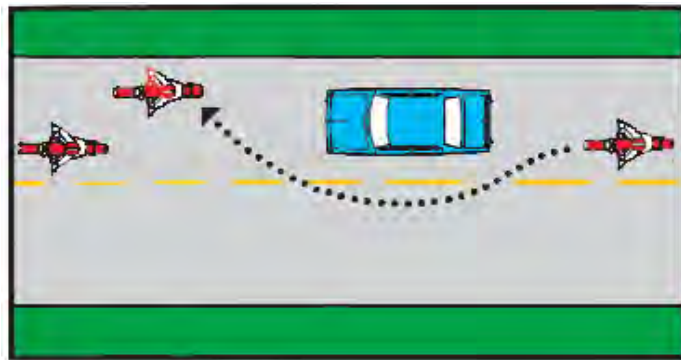

A.

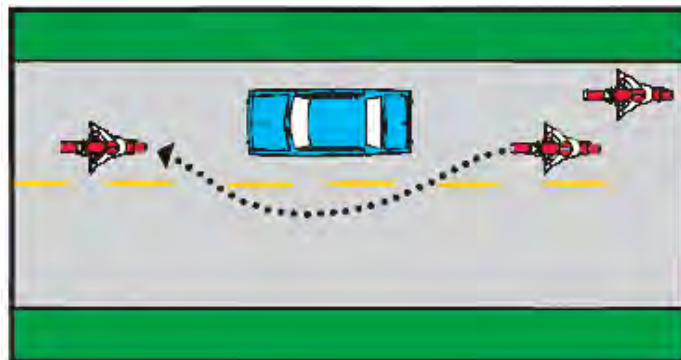

B.

Riders in staggered formation should pass one at a time.



Passengers And Cargo

Part of the fun of owning and operating a motorcycle is taking others to ride. But be certain you do it safely.

Carrying passengers or any other load alters the handling characteristics of your motorcycle. An extra burden is placed on the novice rider, and even an experienced rider still has to be more careful in this situation. If you want to carry a passenger on a motorcycle, you must make some special considerations. Be sure you have the necessary experience and know-how to carry a passenger. Your motorcycle should be designed and equipped to carry an extra rider. All packages should be strapped to the carrying rack. You may not carry any package or articles which prevent you from keeping both hands on the handlebars.

Instruct your passenger to lean with you when turning, not against you. A leaning passenger can actually steer a motorcycle. Caution the passenger not to lean except when you do; know how to compensate if your passenger leans the wrong way or at the wrong time. If under 21 years of age, your passenger must wear a helmet and face shield. Loose clothing or equipment such as shoe laces, pant legs, and scarves can become tangled in the chains or spokes, so check your passenger's clothing carefully before riding.

Never allow a passenger to ride sidesaddle. The passenger should always ride behind you and should hold firmly and securely onto your waist, hips, midsection, or the handgrips provided on some cycles. The passenger should avoid unnecessary distraction or dismounting until told to do so.

Do not carry a passenger unless the motorcycle is equipped with a saddle and foot pegs for two persons. Remind the passenger to keep his or her feet on the passenger's foot pegs at all times.

Remember to ride at slower speeds. Give yourself extra time and distance to slow down and stop.

A.

Handling Hazards and Dangerous Surfaces

You must be constantly alert in residential areas for children and other pedestrians who may dart from between parked cars or from behind other obstacles that block your vision.

Animals, particularly dogs that like to chase motorcycles, are a hazard for you. Always be ready to act quickly if a pedestrian or animal appears in your path.

You should also be constantly alert for automobiles and trucks backing from driveways, which pose a special hazard for motorcycle riders.

Raised pavement markers placed on center lines and at other locations may be hazardous for motorcyclists if crossed at an angle or while leaning in a turn.

Handling Dangerous Surfaces

Your chance of falling increases whenever you ride across:

- Slippery surfaces.
- Uneven surfaces or obstacles.
- Railroad tracks.
- Grooves and gratings.

Motorcycles handle better when ridden on surfaces giving good traction. Surfaces that provide poor traction include:

- Wet pavement
- Gravel roads, or places where sand and gravel have collected on paved roads. (A motorcycle is more stable on pavement than it is on gravel.)
- Mud, snow, and ice.
- Lane markings and steel plates and manhole covers, especially when wet.

Handling Slippery Surfaces

There are a number of things you must do to ride safely on slippery surfaces:

- Reduce Speed-Slow down before you get to a slippery surface. Your motorcycle needs more distance to stop. By going slower, you can stop and turn more gradually, lessening your chances of skidding.
- Avoid Sudden Moves-On slippery surfaces, any sudden change in speed or direction can cause a skid. Speed up, shift gears, turn and brake as little and as smoothly as possible.
- Use Both Brakes-Don't be afraid to use the front brake as well as the rear brake when making a quick stop on wet pavement. The front brake is still more effective than the rear brake, even on a slippery surface. Just be careful to apply it gradually and avoid locking up the front wheel. Don't squeeze the brake lever too hard.
- Avoid Slippery Areas-Wet wooden surfaces or wet leaves in the fall can be slippery as a patch of ice. Avoid them when possible. If not, be sure to drive as slowly as possible and stay off the brakes to avoid skidding. Try to find the best surface available, and use it.
- Ride in the tire tracks left by cars.
- Watch for oil spots when you stop or park.
- Stay away from the edge of the road, particularly when making sharp turns at intersections and when getting on or off



interstates at high speeds. Dirt and gravel tend to collect among the sides of the road-especially on curves and ramps leading to and from highways

- Try to stay on the driest, least slippery part of the lane at all times. Rain dries and snow melts faster on some sections of a road than on others.

Uneven Surfaces And Obstacles

Watch for uneven surfaces such as bumps, broken pavement, potholes, or railroad tracks. If you have to ride over them, or obstacles such as a piece of tire tread or tail pipe, here's what you should do:

- Slow down to reduce the jolt.
- Make sure the motorcycle is straight up.
- Rise slightly off the seat with your weight on the foot pegs so you can absorb the shock with your knees and elbows.

Rising off the seat will cut your chances of being thrown off the bike. However, controlling the throttle can be somewhat tricky. Practice this technique in a safe area (such as a deserted parking lot) before you try to do it on-street.

If you ride over an object on the street, it's a good idea to pull off the road and check your tires and rims for damage before going any further.

Grooves and Gratings

When you ride over rain grooves or metal bridge gratings, the motorcycle shakes. It's an uneasy, wandering feeling, but it's generally not dangerous. The best thing to do is relax, stay on course, maintain speed, and ride straight across. Some riders make the mistake of trying to cross these surfaces at an angle. This may reduce the uneasy feeling, but it also forces the rider to zigzag to stay in lane. The zigzag is far more dangerous than the wandering feeling.

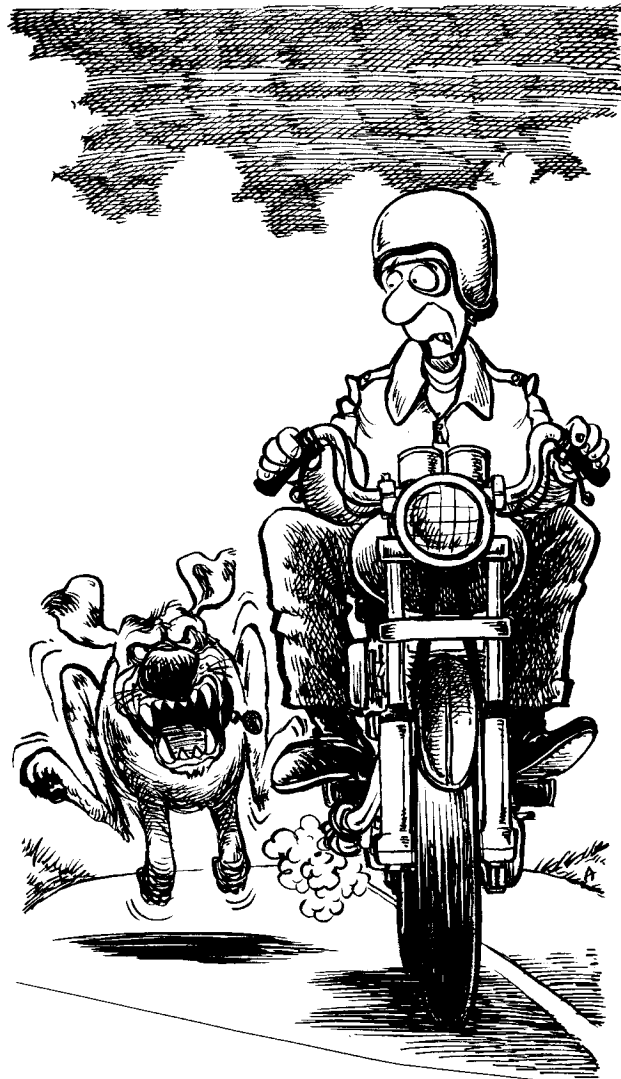

Always be ready to act quickly if a pedestrian or animal crosses your path. Be cautious for their safety...and for your own.

Motorcycling Laws and Information

The following laws apply almost entirely to motorcyclists and should be well known to every motorcycle operator.

1. A person shall ride a motorcycle only while sitting astride the seat, facing forward, with one leg on each side of the motorcycle.
2. No person shall operate a motorcycle while carrying any package, bundle or other articles which prevent him from keeping both hands on the handlebars.
3. No operator shall carry any person, nor shall any person ride, in a position that will interfere with the operation and control of the motorcycle or the view of the operator.
4. No person riding a motorcycle shall attach himself or the motorcycle to any other vehicle on a roadway.
5. All motorcycles are entitled to full use of a lane and no motor vehicle shall be driven in such a manner as to deprive any motorcycle of the full use of a lane. This shall not apply to motorcycles operated two abreast in a single lane.
6. The operator of a motorcycle shall not overtake and pass in the same lane occupied by the vehicle being overtaken.
7. No person shall operate a motorcycle between lanes of traffic, or between adjacent lines or rows of vehicles. Items 6 and 7 shall not apply to police officers in the performance of their official duties.
8. Motorcycles shall not be operated more than two abreast in a single lane.
9. Any motorcycle carrying a passenger other than in a sidecar or enclosed cab shall be equipped with footrests for such passengers.
10. No person shall operate a motorcycle unless it is equipped with a rear view mirror that will afford the operator ample vision to the rear at all times.
11. Every person operating a motorcycle shall be granted all the rights and shall be subject to all of the duties applicable to the drivers of motor vehicles, except as to special regulations or other provisions of law which by their nature would not apply.
12. Any person who operates a motorcycle or motor-driven cycle on public streets or highways shall, while so engaged, have the headlights of such motorcycle or motor-driven cycle turned on and the light burning.
13. Any person under 21 years of age who operates or rides a motorcycle or motor-driven cycle must wear an approved motorcycle helmet. Such helmet must be equipped with either a neck or chin strap and be reflectorized on both sides with at least four square inches of reflectorized material, provided the helmet

- is not constructed of a reflectorized material.
14. Any person under 21 years of age who operates a motorcycle or motor-drive cycle must wear goggles or face shield affixed to a protective helmet or have a windshield affixed to the front of the cycle.
 15. If a motorcycle is five brake horsepower or less it may not be ridden on limited access highways (freeways such as the interstate highways).

Some points to remember

1. Know your motorcycle before you begin riding. Know its controls, and make certain it is adjusted for you.
2. When learning, choose a mature, experienced rider as your instructor.
3. It takes time to become a safe, proficient rider. You will need practice, so don't try to learn everything at one time.
4. When you have a choice, avoid heavily-traveled streets.
5. Before every trip, make certain your cycle is in sound mechanical condition.
6. Know and obey all traffic laws and rules of the road.
7. Drive defensively at all times. As a motorcyclist, you must never assume you have been seen by the other motorist.
8. Watch for road hazards that are particularly dangerous to motorcyclists.
9. Keep a cool head. Never show off or ride recklessly.
10. Ride with increased caution at night and when roads are wet.
11. Always wear your protective helmet, properly fastened, and proper eye protection.
12. Laws that apply to all other motor vehicle operations apply to motorcycle operations.

Keep Your Motorcycle in Good Condition

The rider is responsible for the motorcycle being in proper working order. Have it checked regularly and know as much about your motorcycle as you possibly can. The owner's manual is the key to doing this. You should carry it with you at all times and follow the maintenance schedule it suggests.

You will need a tool kit for use at home and when you are on the road. Carrying it with you may save you from walking if you have a breakdown. In your kit you should carry spare parts including spark plugs, fuses and tire repair material.

Before you ride, always check your motorcycle; brakes and steering, tires, oil and fuel levels, chains, sprockets, cables, and lights.

Your life depends on your machine. Be certain it is in the best possible condition.



Motorcycle Test

The test consists of several exercises designed to measure your ability to perform basic vehicle controls and hazard response skills. Most of the exercise involve speed of approximately 15 m.p.h. You will be scored on time and distance standards as well as path and foot violations. The test may be ended for point accumulation, falling or dropping the motorcycle, committing an unsafe act, or failure to follow directions. The following diagrams illustrate the maneuvers you will be asked to perform:

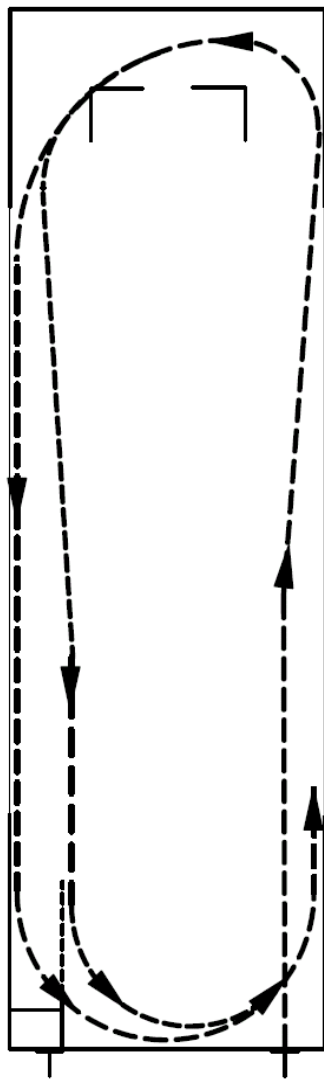

Sharp Turns and U-Turns to the Left

You will be asked to accelerate straight ahead and make a left sharp turn staying inside the boundaries marked by the yellow "L" lines. You must not put a foot down or cross the lines.

Once you have completed the sharp turn, continue around to the far side of the course and ride back toward the start of the course. Then, you will make a left U-Turn, staying inside the boundaries marked by the yellow solid lines or (yellow dashed entry line and solid exit line).

You must not put a foot down or cross the lines. Stop in a straight line after completing the U-Turn and wait for further directions.

You will lose points for putting your foot down or path violations.



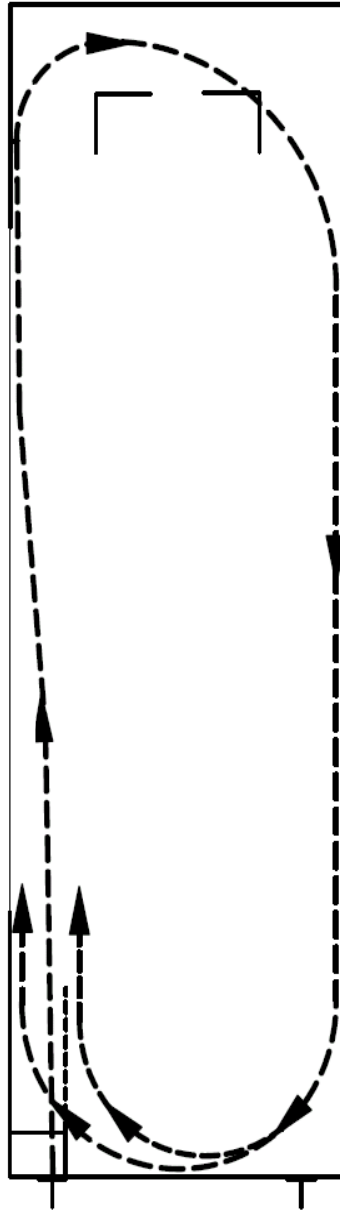

Sharp Turns and U-Turns to the Right

You will be asked to accelerate straight ahead and make a right sharp turn, staying inside the boundaries marked by the yellow “L” lines. Do not put a foot down or cross the lines.

Once you have complete the sharp turn, continue around to the far side of the course and ride back toward the start of the course. Then you will make a right U-Turn, staying inside the boundaries marked by the yellow solid lines or (yellow solid entry line and dashed exit line).

Do not put a foot down or cross the lines. Stop in a straight line after completing the U-Turn and wait for further directions.

You will lose points for putting your foot down or path violations.

Cove Weave - Regular Stop

You will ride to the right of the first cone, to the left of the second, and so on. Weave past all five cones without touching or skipping a cone, or putting your foot down.

After rounding the last cone, continue around to the far side of the course. Ride down the perimeter toward the start of the course. Make a smooth, non-skidding stop with your front tire inside that white box.

Once stopped in the box, your front tire cannot be touching any painted lines. You will lose points for hitting or skipping a cone, putting a foot down, or stopping before, after, or with your front tire touching the box.

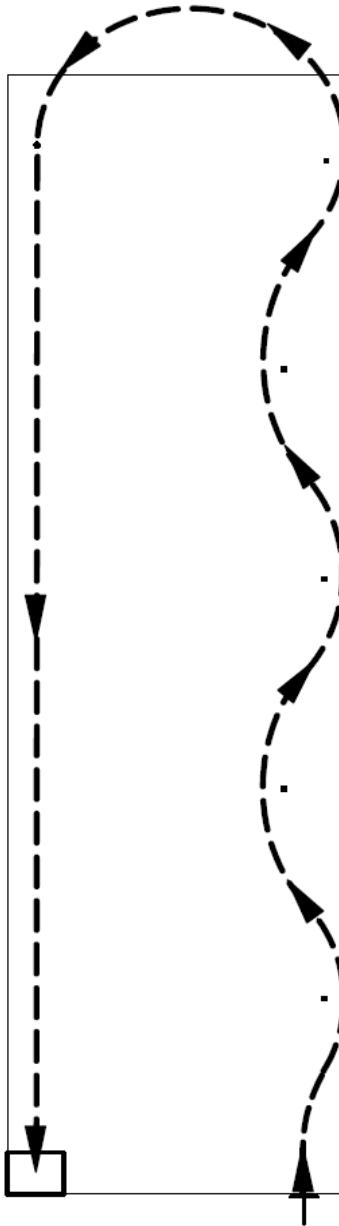



156

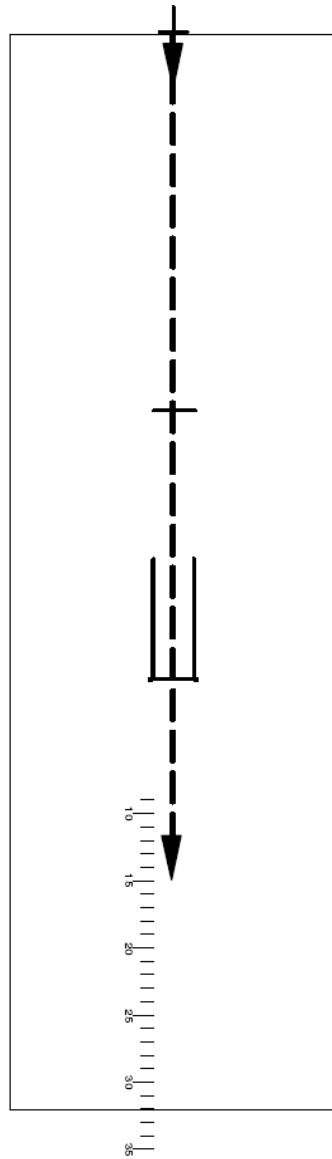

Sudden Stops

You will accelerate straight toward the braking area.

Stabilize your speed between 12-20 mph by the time you reach the first red line. Maintain a steady speed from the first red line until you reach the second red line. When your front tire passes the second red line, stop as quickly and as you safely can.

Remain stopped until instructed to move. You will not be assessed points for skidding.

You will lose points for failing to stop in a specified distance, failing to use both brakes or failing to obtain proper speed or anticipate the stop.

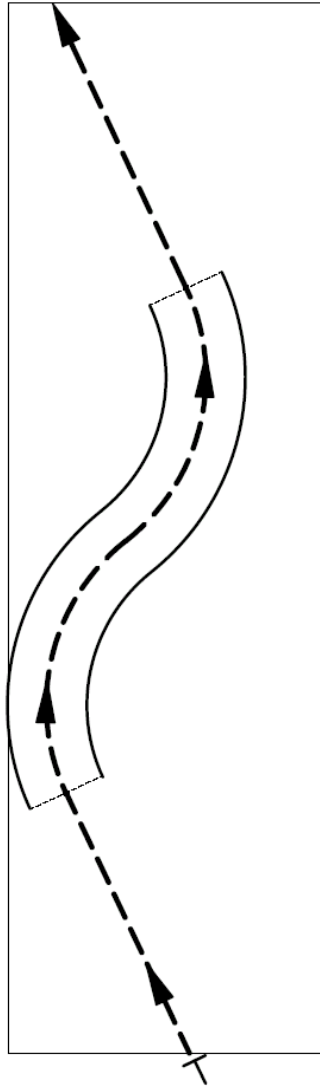

Cornering

You will ride through the multiple curves marked by the white lines at a speed between 10 to 15 mph.

You must stay within the boundaries marked by the curved white lines while slightly accelerating through the curve.

After exiting the curved lines you may slow down and then turn in either direction to return to the end of the course.

You will lose points for path violations, decelerating or failing to obtain the proper speed.





158

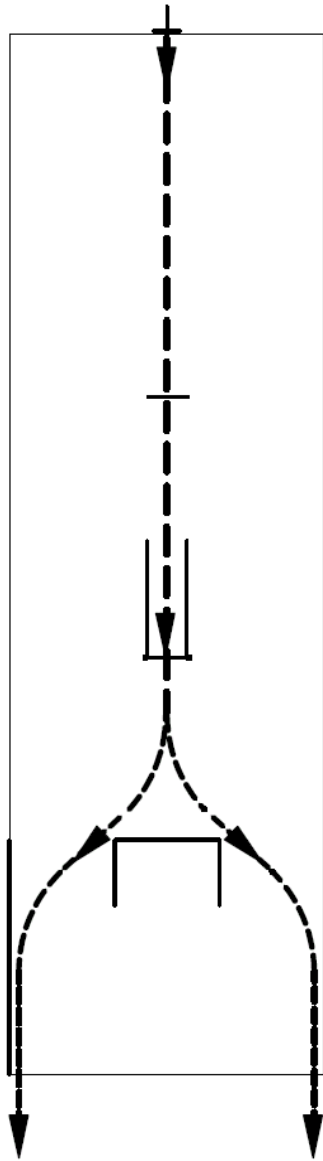

Obstacle Avoidance

You will accelerate toward the path marked by the red lines. Stabilize your speed between 12-18 mph by the time you reach the first red line.

Maintain a steady speed from the first red line until you reach the second red line. When your front tire passes the second red line, swerve to avoid the obstacle box marked by the yellow lines.

Avoid crossing the yellow obstacle box while staying inside of the yellow sideline. Once past the sideline, stop and wait for further instructions.

You will lose points for hitting obstacle box or sideline, failure to obtain proper speed or braking during the swerve.

Motorcycle with Sidecar Skills Test

Safely operating a motorcycle with a sidecar depends largely on your knowledge and skills. The skills for a motorcycle with sidecar operation require a lot of practice. If you have just learned to handle a motorcycle with a sidecar and have very little riding experience, the most important part of learning to ride is still ahead. Before you go out on the street with other traffic, there are certain basic skills needed for your safety. To make sure you have the basic skills to ride, you will be given a riding test.

When you report for your test, it is recommended that you have:

- Protective clothing that covers your body (gloves, boots, long sturdy trousers, long sleeve shirt or jacket).
- An approved helmet and eye protection are required for operators under the age of 21.

During the on-cycle test, you will be graded on how safely you handle your motorcycle with sidecar. For example, you may be tested on:

- Selecting safe speeds while going straight and turning.
- Picking the correct path and staying there.
- Making normal and quick stops.
- Making normal and quick turns.

The Examiner will score you on factors related to safety, such as:

- Distance - Did you stop in the space allowed?
- Time - Did you turn fast enough to handle the situation?
- Position - Did you keep the system in the proper path?

The test will end immediately if you:

- Commit an unsafe act.
- Disregard or fail to understand instructions.

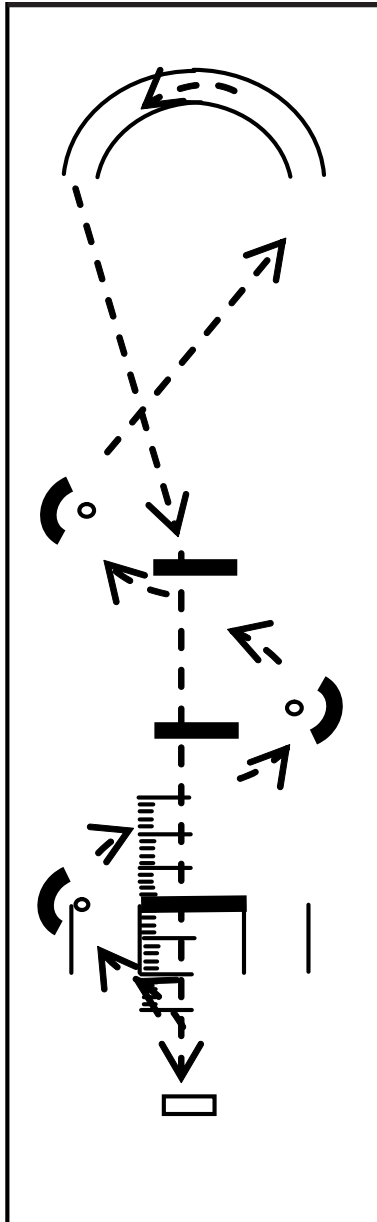

Vehicle Placement - Cone Weave and Turn

Ride to the left of the first cone, to the right of the second cone and so on. Weave past all three cones without hitting or skipping a cone. Your inside wheel must stay between the cone and curved line, not hitting or skipping any of them. After rounding the last cone make a left-hand turn through the curve marked by the lines at approximately 10 MPH. You must stay between the lines of the curve.

Points will be assessed for:

- Stalling the engine.
- Hitting or skipping a cone.
- Riding too slowly.
- Path violation, inside tire more than four feet from weave cone or any tire outside the curve boundary.

Cornering and Normal Stop

Ride toward the left of the curve quickly accelerating. Brake prior to making a right hand turn through the curve at approximately 10 MPH. You must stay between the lines and the curve. After completing the turn, ride to the end of the course and make a smooth stop without skidding the tires and with your front tire inside the box. Your front tire must not touch the painted lines. You will be timed from the time you start moving forward until you are stopped near the box.

Points will be assessed for:

- Stalling the engine.
- Skidding tires.
- Stopping before, after or with your front tire touching the box.
- Riding too slowly.

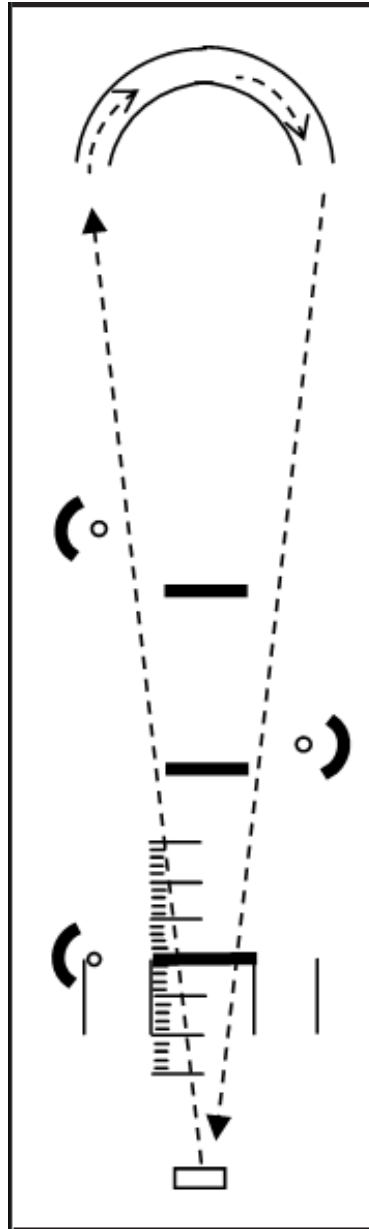



162

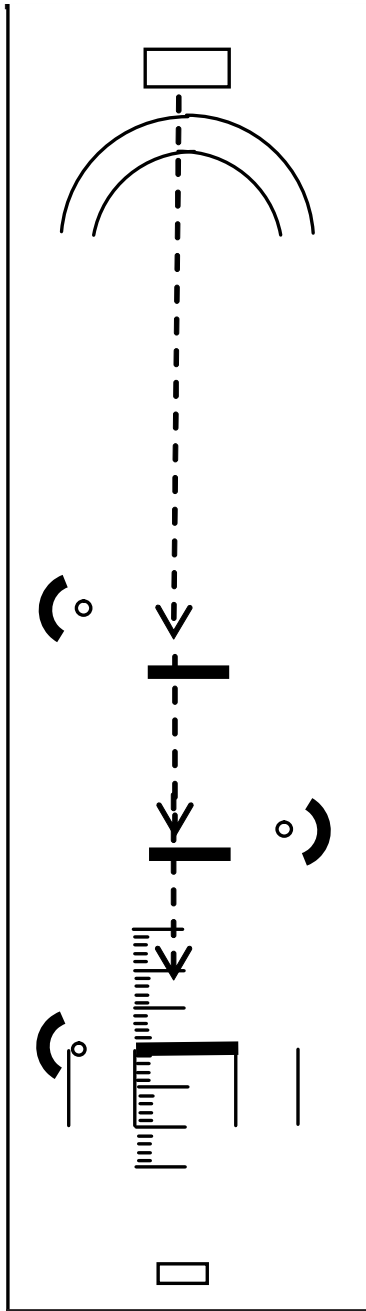

Quick Stop

Position your vehicle with your front tire on the "T" at the end of the course. On signal, accelerate straight up the path and shift into second gear. Stabilize your speed between 15 and 20 MPH by the time you reach the first line. Maintain a steady speed. When your front tire passed the second line, stop as quickly as you safely can while downshifting to the first gear. Remain stopped.

Points will be assessed for:

- Stalling the engine.
- Failure to stop in specified distance.
- Failure to use both brakes.
- Failure to obtain proper speed.

Obstacle Avoidance - Swerve

Position your vehicle with the front tire on the line or "T" at the other end of the course. On signal accelerate straight up this path. Stabilize your speed between 12 and 18 MPH by the time you reach the first line. Maintain a steady speed. After your front tire passes the second line swerve to the right. Avoid the obstacle line and stay inside the boundary line. Do not touch either line. Once you have passed the lines marking the box, stop and wait for further instructions.

Points will be assessed for:

- Stalling the engine.
- Tires crossing the lines.
- Improper speed.

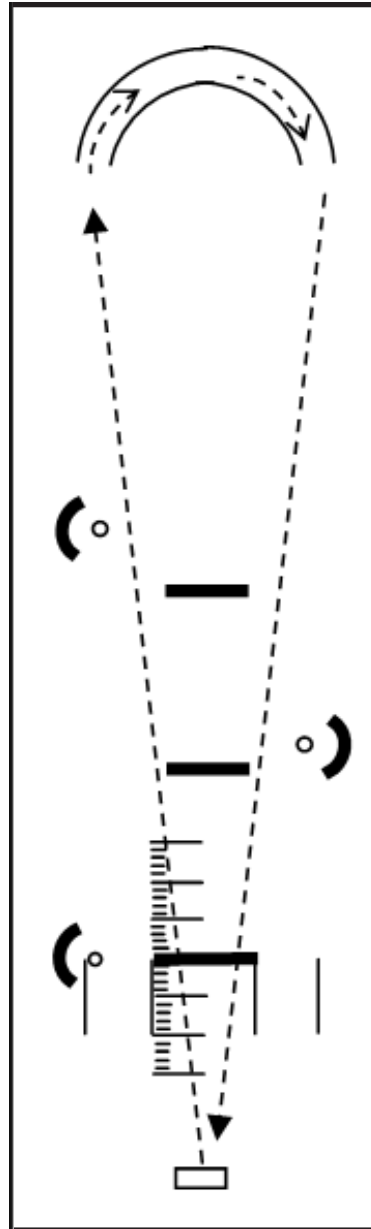

Generally, you will be evaluated on your ability to control the cycle, speed maneuverability, left turns, right turns, quick stops, straight line riding, posture, used of clutch, brakes and overall attention that can be observed and scored.

You can stop the test anytime you desire. You should not attempt an exercise that you do not feel you can perform. If an exercise is too difficult for you, or you cannot safely follow instructions, tell the Examiner. You will be allowed to come back another day after you have taken more time to practice.

If you motorcycle with sidecar is wider than six feet, let the Examiner know before beginning the skills test. The Examiner may need to make additional modifications to the skills test pad.



Mopeds



MOPEDS

Moped Riding In South Carolina

The 1986 session of the General Assembly of the State of South Carolina enacted a law regulating the licensing of moped operators. The regulations govern the equipment required and proper use of the moped. Following are excerpts from that law that help provide you with a basic understanding.

What Is A Moped?

A moped is a cycle with pedals or without pedals and with a motor of not more than fifty cubic centimeters. Its power will not exceed two brake horsepower and the motor is not capable of propelling the vehicle at a speed in excess of thirty miles an hour on level ground.

The power drive system must function directly or automatically without clutching or shifting after the engine is engaged.

MOPED STANDARD EQUIPMENT



Moped Equipment

1. Operable pedals if the moped is equipped with pedals.
2. At least one rearview mirror.
3. Operable running lights. Lights must be on whenever moped is in operation.
4. Brake lights activated when either brake is used.
5. Driver and passenger must ride upon permanent regular seats and not carry more persons than the moped is designed to carry.

The Moped Operator

To operate a moped on the public highways and streets, you must be at least 14 years of age, have a valid driver's license/ motorcycle license, a permit or a valid moped operator's license.

A person whose driver's license has been suspended for six months or less is not required to obtain a moped operator's license or possess a valid driver's license during the period of suspension when operating a moped.

No person may operate a moped at a speed in excess of twenty-five miles an hour. A person who violates the provisions of this section is guilty of a misdemeanor and, upon conviction, will be fined.

A person is eligible for a moped operator's license without regard to his eligibility for or the status of any other driver's license or permit. The Department may suspend, revoke, or cancel a moped operator's license only for violations committed while operating a moped. A moped operator's license may be suspended, revoked or cancelled in the same manner and upon the same grounds for which any other motor vehicle operator's license or permit may be suspended, revoked or cancelled.

Obtaining a Moped License

Documents required to obtain a moped license are the same as those needed for Class D, E, F and M. An applicant for a moped operator's license must successfully pass an eye examination and a test of the applicant's ability to read and understand highway traffic signs and knowledge of traffic laws. To prepare for this test, an applicant should read and understand the sections of this handbook pertaining to the Rules of the Road, Signs and Signals, Motorcycles, and the General Information.

The department may require further examination as it considers necessary to determine the applicant's fitness to operate a moped on

the highways. A license will expire on the licensee's birthday every five years. It must be signed by the licensee and be in his/her possession when operating the moped.

Special Regulations

1. The Department may not issue a beginner's permit or special restricted license to any person convicted of a second or subsequent violation of operating a moped on the public roads while under age, until that person is fifteen and one-half years of age.
2. The Department may suspend, revoke, or cancel a moped operator's license only for violations committed while operating a moped.
3. Any person who sells a moped must clearly and conspicuously label each moped with its specifications. Any seller who fails to label a moped as such is guilty of a misdemeanor, punishable by fine and/or imprisonment.
4. The moped must have a permanent and regular seat attached. No moped may be used to carry more persons at one time than the number for which it is designed and equipped.
5. It is unlawful for any person to sell a moped for use on the public highways and streets of this state or operate a moped on the streets of this state without at least one rearview mirror, operable running lights, and brake lights which are operable when either brake is deployed.
6. The operator of a moped must have the operating lights turned on at all times while the moped is in operation on the public highways.
7. It is unlawful for any person to modify or change the equipment of a moped so that the vehicle exceeds two brake horsepower and produces speeds in excess of 30 miles per hour on level ground.
8. Any person who sells, solicits, or advertises the sale of mopeds shall clearly and conspicuously label each moped with its specification, including, but not limited to, the brake horsepower of the motor and the maximum speed of the vehicle on level ground.

Any seller of mopeds who fails to label a moped or who knowingly labels a motorcycle or motor-driven cycle as a moped is guilty of a misdemeanor and, upon conviction, must be fined. Each vehicle which is incorrectly labeled and each moped which is not labeled is a separate violation.



Safety

If you will be riding at night, you must have a light on the front and a rear tail light.

Mopeds do not have to undergo an annual inspection, but you should check them before every trip to make sure they are in good operating condition.

The law does require that moped operators under 21 years of age wear helmets, goggles or face shield. It would be an intelligent decision on your part to also wear protective clothing.



Traffic Signs, Signals, Markings



Traffic signs and signals are essential to highway safety.

South Carolina's traffic signs, signals and pavement markings conform to the nationally recommended standards. In many cases, the signs use easily recognized symbols or pictures rather than words.

The following section shows a sampling of signs you will see on the highway, including a number of important regulatory, warning and guide signs. A driver must know the meaning of all the signs to be able to drive safely.

There are seven basic shapes of signs, each shape having a different meaning. Each color also has a particular meaning.

For your own safety, learn the signs that are shown and explained on these pages.

Regulatory Signs

The stop sign **(1)**, most important to your safety, is the only eight-sided (octagonal) sign you will see. A vehicle approaching a stop sign shall stop at a clearly marked stop line, a marked or unmarked crosswalk, but if none, then at the point nearest the intersection where the driver can see in both directions without entering the cross traffic in front of him/her.

The three-sided yield sign **(2)** means you are approaching an intersection where you must yield to any lanes you intend to enter or cross approaching from the right or left. This sign is also found at un signaled railroad crossings where you must yield to approaching trains. Whenever this sign is present, it is your responsibility to slow down, look to the right or left and yield to oncoming traffic. The yield sign is also found at un signaled railroad crossings where you must yield to approaching trains.

Sign **3**, Do Not Enter, which you will see particularly on ramps to interstates, tells you that you must not enter the road or highway because it is used only for traveling in the opposite direction.

Sign **4** tells you that you are entering or traveling on a one-way roadway in the wrong direction. You should immediately stop and reverse your direction.

Anytime you see a sign (such as sign 5) bearing a red circle with a slash mark across a black arrow (or other symbol), it means don't do whatever is shown by the arrow (or other symbol). On sign **5**, the message is that you must not make a U-turn.





1



2



3



4



173



5

Sign 6 with the red circle and red slash mark across the arrow pointing left means you must not make a left turn. Similarly, sign 7 means that you cannot make a right turn.

Sign 8 with an arrow curving to the right around a traffic island (bullet-like) symbol on the left appears when you approach a divided highway or traffic island where traffic must keep right. (It can show that traffic must keep left by having the arrow pass to the left of the island.)

Sign 9, which has been placed on all controlled access interstates in South Carolina, tells pedestrians and drivers of slow-moving vehicles they are prohibited from using the interstate.

Sign 10 indicates a minimum speed at which it is safe to travel. This is usually 40 or 45 miles per hour. No traffic moving more slowly than the minimum speed limit may use the highway.

Sign 11 declares that passing is illegal when indicated by the pavement markings.



6



7



8

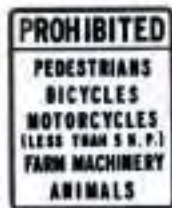

9



10

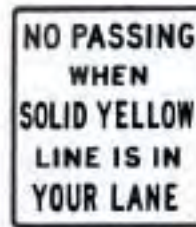

11



Other Important Signs

Signs **12** and **13** are lane-use control signs. Sign **12** is used over a lane to show that all traffic in that lane must turn left. Sign **13** is used over a lane where a left turn or straight movement is permitted. Similar signs are used to restrict lanes to right turns and other combinations of traffic movements.

Sign **14** is used at some intersections to tell you that you **CANNOT** turn right on red at that intersection. The law permits you to turn right on a red traffic signal unless a sign prohibits it. If no sign **14** is present, you must first stop, look both ways and yield to any other vehicles or pedestrians lawfully in or near the intersection.

Sign **15** means slower traffic should drive in the right (outside) lane and faster traffic should take the inside left lane.

Sign **16** tells you that the speed limit is 65 miles per hour. However, signs showing lower limits appear on some roads (see sign **10**). When used, sign **10** is always posted directly beneath sign **16**.

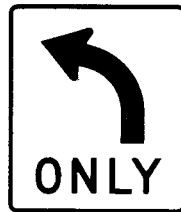

12

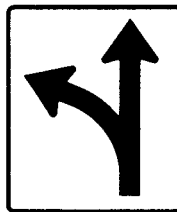

13



14



15

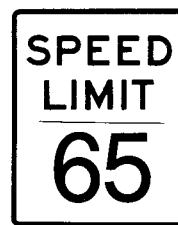

16

Warning Signs

Sign **17** tells you that you are approaching a traffic signal and should slow down or be prepared to stop.

The two arrows pointing in opposite directions (sign **18**) mean that you are on or approaching a street or highway carrying two-way traffic. These roads will usually be marked with broken yellow center lines and you must drive to the right of that line except when passing.

Sign **19** shows you (with a picture of a skidding car) that the road on which you are traveling can be slippery when wet and that you should reduce speed.

Sign **20** shows a truck going down an incline, indicating you are approaching a hill.

Sign **21** tells you that you are approaching a location where traffic may be entering from another roadway and you will be merging with this traffic. Here the sign shows that traffic may be entering from your right.

The two arrows pointing in opposite directions (on sign **22**) with the traffic island (bullet-shaped symbol) at the top of the sign tells you that a divided highway is ahead. You must move to the right and should not pass within this area.

Sign **23** showing the opposite arrows with the traffic island (bullet-shaped symbol) at the bottom means that the divided highway is coming to an end and that you must prepare to meet traffic coming toward you in the opposing lane.

Sign **24** is very important to the driver of a truck or van that may be too tall to drive under a bridge having only 12 feet, 6 inches clearance. These signs tell the amount of space between the road and the overpass.

Sign **25**, in a five-sided pentagonal shape, is a very important sign. When you see the picture sign with two children's figures, you know you are approaching a school. When you see one of these, slow down and be prepared to stop. Farther along, the second pentagon-shaped sign (**26**) with the line representing a crosswalk tells you that children may be crossing the road at or near that point going to and from school. A sign shaped like a one-room schoolhouse means drive slowly and, carefully and be prepared to stop.

A yellow diamond-shaped sign (**27**) picturing an adult tells you that just ahead is a location where pedestrians often cross. It cautions you to drive slowly and, carefully and be prepared to stop.





17



18



19



20



21



22



23



24



25



26



27



Sign 28 is immediately understandable. It shows a deer leaping in the air and warns you that deer often cross the road in that area. The driver should be on the lookout for this animal, particularly at night.

Signs 29 and 30 give notice that you are approaching an intersection and should watch for entering traffic. The black lines show you what kind of intersection it is. Sign 29 tells you it is a “branch” intersection with traffic entering from one side. Sign 30 tells you that it is a crossroad. Be prepared to slow down, and observe any special speed limit instructions, in the event a car enters or crosses the highway from the side road.

Signs 31 and 32 give notice that you are approaching a curve. The black line represents the road you are on and, the type of curve you can expect and tells you that you must slow down. Sign 31 tells you that you must turn left and then right. Sign 32 tells you must be prepared for a rather sharp turn to the right. The smaller sign (sign 33, which is displayed on the post beneath the larger sign) shows the highest speed at which you can make the turn safely. Exceeding the speed posted on this type of sign is not only hazardous but also a traffic violation.

Sign 34 informs you of the highest safe speed at which you may drive on interchange ramps when leaving the interstate.



28



29



30



31



32



33



34



Railroad Crossings

Signs that warn about railroad crossings are among the most important a driver needs to know.

The familiar round sign (35) with black **X** and **RR** (for railroad) on a yellow background is used in advance of the crossing. At the track itself, you will see the standard railroad crossbuck.

Sign 36 indicates that a side road crosses a railroad track. Be careful when making a turn across the tracks.

Some crossings are protected by flashing lights and crossing barrier gates. But every driver should approach all crossings with caution and always drive safely enough to be able to stop for any railroad crossing. You cannot legally go around barrier gates while they are down or while lights are flashing.

The crossbuck (37) is placed at all railroad crossings. Slow down, look and listen before crossing. The sign below the crossbuck indicates the number of tracks. Yield to any approaching trains.

If you see sign 38 in advance of a railroad crossing, a low ground clearance vehicle or trailer may get stuck on the crossing and should avoid it.



35



36



37



38

Work Zone Signs

Whenever road work is performed on the highway, special signs are displayed to advise you and guide you through the work area. Most signs and other traffic control devices associated with work zones are orange. Use caution and lower your speed as you travel through these areas for your safety and the safety of the workers.

Sign **39** indicates a work zone is ahead. Sign **40** warns you that a flagman is ahead and that you will need to obey the directions that he or she provides. Sign **41** indicates that you will start a detour 1,000 feet ahead.



180



39



40



41

Guide Signs

The miles are numbered from South to North and from West to East on Interstate highways. In South Carolina the numbering for I-20, I-85 and I-95 begins at the Georgia line. I-26 begins at the North Carolina line, and I-77 begins at Columbia. Incidentally, interchanges in South Carolina are numbered according to the nearest milepost.

If you have trouble, give the best directions you can, including the nearest milepost number, which will help to pinpoint your exact location.

Guide signs are used on the state's interstates well in advance of an exit taking traffic to another highway. It also bears the names of the places you may reach by taking the exit. These signs show exit numbers corresponding to the number of the milepost nearest the interchange. Two miles before an interstate exit, sign **42** gives the exit number (the same as the nearest milepost) and tells what places may be reached by taking the exit. Sign **43** alerts you to the next exit, the road number, direction you will be traveling, and town you could reach.



42



43



The exit sign is used to indicate where and in what direction a ramp leaves the interstate. The new sign (44) has the exit number on it.

Sign 45 is a destination sign. Some, but not all such signs, give the distance to each town listed and arrows point in the direction you must take to get to each town. Sign 46 is used for interchanges having more than one exit ramp. It shows the driver the route and direction in which he will be traveling, as well as the town or city to be reached by taking the exit.



44



45



46



Route Markers

When planning a trip you'll want to know the best route to take. And if you want to go safely, and save time and travel costs at the same time, you should plan your trip carefully, using a good road map.

Each route shown on the map is marked by a number. The route number on the map corresponds with the numbers posted on the highway. Therefore, by choosing from the map the route you want to take, you can reach your chosen destination simply by following the numbers posted on the highway.

There are several different highway systems. The routes in each system are posted with a particular type of marker.

Mileposts

Green and white mileposts (47) are posted at one-mile intervals along the Interstate routes. They tell you the progress you are making. Since they are placed at one-mile intervals along the route, they are also useful in reporting locations of accidents, disabled vehicles and other emergencies.

Interstate System Route Marker

This red, white and blue sign (48) is the standard marker erected on Interstate System highways throughout the nation. The sign not only gives the number of the highway but also the name of the state in which the marker is located. It is used on the highway itself and also on approaches to the highway at or near traffic interchanges.



47



48



U. S. Number Route Marker

This sign with black numerals on the familiar U.S. shield (sign **49**) is used on all U.S. numbered routes. A U.S. numbered highway, like an Interstate System highway, extends into or through more than one state; such highways are owned and maintained by the states in any case.

State Route Marker

Signs **50** and **51** are state route markers. A state route is a primary or main route extending from one major point in South Carolina to another, usually across county lines.

Business And By-Pass Plates

Some U.S. and state routes have a plate mounted over them. A "Business" sign (**52**) means the route leads through the town's business area. The word "By-Pass" (**53**) means the route by-passes the town's business area and therefore is the faster route.

Secondary System Road Marker

Sign **54** is a marker that is used to designate a state secondary system route. The first number after the letter "S" is the number of the county and the last number is the road number.

There is a separate set of secondary road numbers for each county. You will find only a few of the more important secondary road numbers on your state primary system map because there are too many secondary roads to show. However, they are all shown on county maps, which may be purchased by mail from the central office of the Department of Transportation. Secondary system roads are local roads, built to serve traffic in both rural and urban areas. In rural areas they are not intended as through routes and should not normally be used by drivers who are not familiar with the area.

Evacuation Route

In the event of a hurricane, a mandatory evacuation may be declared for the coastal areas of South Carolina. Sign **55** indicated the road or highway is used as an evacuation route in this type of emergency.



49



50



51



52



53



54



55



185

Pavement Markings

A broken yellow line (**56**) indicates that you are on a two-lane road and can expect oncoming traffic in the lane to the left of the line. Passing is permitted where there is ample passing distance and the opposing lane is clear of traffic.

A double yellow line (**57**) means that it is illegal to cross the marking from either direction in order to pass another vehicle. A solid yellow barrier line (**58**) in your lane with a broken yellow line on the other side of it means that you cannot pass. Traffic in the other lane may pass when it is safe to do so.

Broken white lines (**59**) are used to divide lanes of traffic going in the same direction. This type of marking is frequently seen on wide streets within a city, as well as on interstate highways, other freeways and roadways carrying traffic in one direction.

A special type of yellow barrier line is used to mark a median as a “refuge area” where vehicles may safely wait to turn left, out of the way of other traffic. Each side of the median area is marked with a yellow line and a broken yellow line. The solid yellow line is next to the lanes of travel, indicating “no passing,” but motorists from either direction must cross into the area to wait and turn left. This median area must not be used for travel along the highway at any time.

Directional Arrows

Pavement arrows shown on this page indicate directions of permitted traffic movement. When approaching intersections where pavement arrows are used, you should enter the lane where the arrow points in the direction you want to go. If you get in the wrong lane you should keep going in the direction indicated by the arrow until it is safe to turn off and get back on the street or highway that will carry you to your destination. Some lanes have double-headed arrows, indicating optional lane usage. Lane control signs sometimes are placed above the roadway to supplement the pavement arrow.

A straight arrow (**60**) on the pavement means the lane is only for traffic moving straight ahead and that a vehicle in the lane should not turn either right or left.

An arrow pointing to the left (**61**) means the lane is for left-turning traffic only. An arrow pointing right (**62**) means the lane is for right-turning traffic only.

A two-headed arrow with one head pointing straight ahead and the other pointing left (**63**) means traffic in the lane may go straight ahead or turn left.

A two-headed arrow (**64**) with one head pointing straight and the other pointing right means traffic in the lane may go straight ahead or turn right.





60

61

62

63

64



Intersection Markings

Most intersections in or near cities will have white pavement markings that indicate where you are to stop when directed by a traffic signal or stop sign. You should stop your vehicle with the front of your vehicle at the stopline. This will allow vehicles crossing in front of you to pass safely and allow space for pedestrians to cross also.

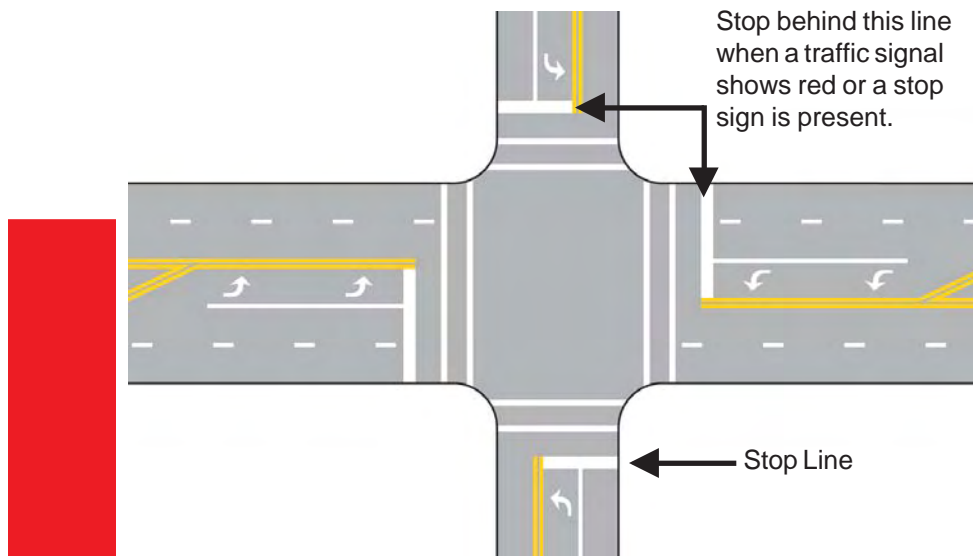

Roundabouts and Traffic Circles

These are found in some areas to help ensure safe passage of traffic through an intersection without necessarily stopping the flow of traffic. A roundabout or traffic circle is a circular intersection with design features that promote safe and efficient traffic flow.

Vehicles travel counterclockwise around a raised center island, with entering traffic yielding the right-of-way to circulating traffic. When entering the roundabout or traffic circle you must negotiate a sharp curve. Slow your speed to about 15 to 20 mph. Slow speeds aid in the smooth movement of vehicles into, around, and out of a roundabout. Once in the roundabout, proceed to the appropriate exit, following the guidance provided by traffic signs and pavement markings. Roundabouts are generally larger and have lower speeds than traffic circles, but both work the same way.

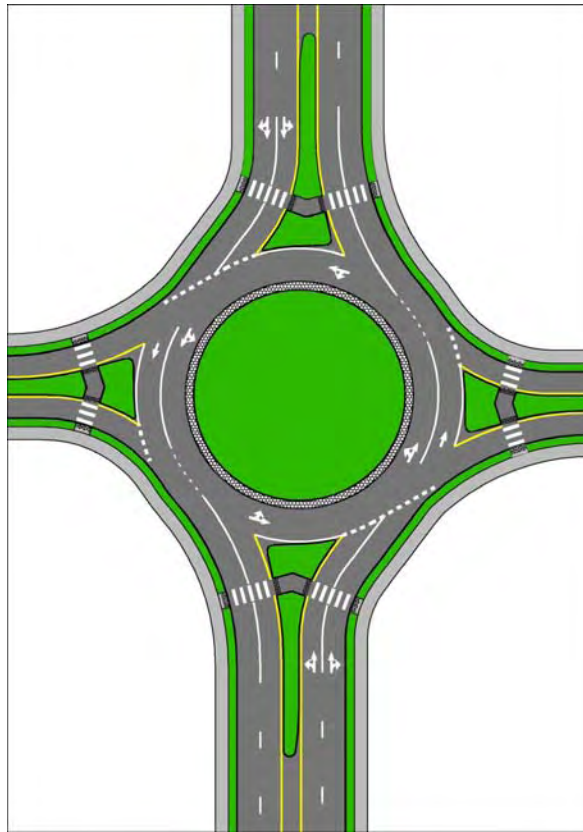

When using roundabouts or traffic circles:

- Slow down as you approach the circle. Sign **65** warns of a roundabout or traffic circle.
- Yield to any traffic in the circle. If another vehicle arrives at the traffic circle at the same time as you do, yield to the vehicle if it is on your right. Also, yield to pedestrians and bicyclists in the traffic circle or roundabout.
- Enter a traffic circle to the right, but steer to the left (in a counterclockwise direction).





65

Always slow down and prepare to yield when approaching a traffic circle or a roundabout. You must turn right to enter a traffic circle or a roundabout and right again to leave it. You must yield to vehicles that are already in the traffic circle or roundabout and to vehicles that are on your right.

Some traffic circles and roundabouts have more than one lane. Lane use signs and markings may be displayed during the approach to indicate where you can go in each lane when you are in the traffic circle or roundabout. Make sure you know where you want to go and are in the proper lane to get there before you enter a traffic circle or roundabout. Do not change lanes or pass any vehicles while in a traffic circle or roundabout.



Signals

Green Go Light (bottom)

A green signal light (example **66**) means you may proceed with caution - but it does not guarantee safe passage through the intersection.

Look in both directions before entering the intersection, then proceed with such care as to avoid hitting any vehicle or pedestrian. Always obey the rules of proper turning or right of way, such as yielding to opposing traffic when you are making a left turn on a green light. Always approach a green signal with alertness and be prepared to stop if the yellow caution light appears. (In cities where traffic lights are arranged horizontally green is at right and red is at the left side.)

Yellow Caution Light

A yellow caution light (example **67**) follows the green signal. The yellow light is a warning that the signal is about to change, and that the red stop signal (example **68**) is about to be shown. Therefore, you should stop your car and wait for the next green light. Traffic situations around us can become critical under these conditions. You must observe and allow for other drivers - side, front and rear - when you are approaching a yellow light.

Red Stop Light

A steady red signal light (example **68**) means that you must stop before entering a crosswalk or intersection and remain at a standstill until the green light appears, unless a signal permits a special movement of traffic to proceed. An exception to this rule permits traffic facing a red signal to turn right except where a sign prohibits a turn on red. When turning on red you must stop before entering the crosswalk on the near side of the turn, yielding right of way to pedestrians lawfully within and adjacent to the crosswalk and to other traffic lawfully using the intersection.

Green Arrows

A green arrow (example **69**) means you may proceed carefully only in the direction in which the arrow is pointing, but must give the right of way to pedestrians and vehicles already lawfully within the intersection. Often a signal may be associated with a particular lane, and you may travel only in the direction indicated by the signal facing your lane, as in example **69**.

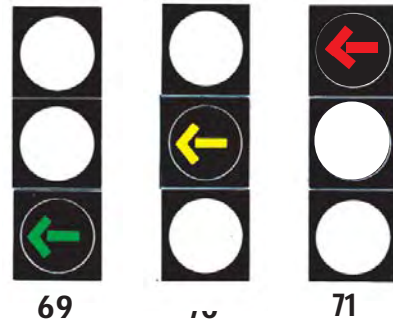
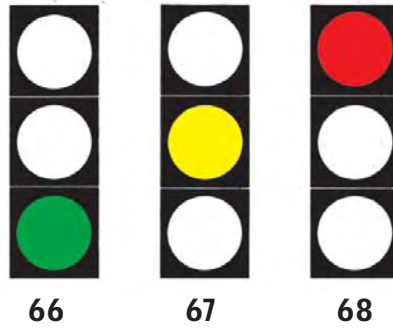

Yellow Arrows

In many cases, the familiar yellow caution light is used after the green arrow to warn that the red stop light will appear. In certain cases, as in example 70, a yellow arrow may be used to indicate that the green arrow for a turn has ended and you must obey the signal that next appears.

Red Arrows

A steady red arrow signal (71) means that you must stop for the direction in which the arrow is pointing before entering a crosswalk or intersection and remain stopped until the green arrow appears for this movement.

Flashing Red Light

A flashing red light (72) requires you to stop completely, as at a stop sign, and proceed when you can do so safely.

Flashing Yellow Light

A flashing yellow light (73) requires you to slow down to a safe and reasonable speed and to proceed with caution.

Lane-Direction-Control Signals

Often referred to as “reversible lane signals,” these devices (example 74) can be used to relieve congestion on some heavily traveled streets during the morning and afternoon rush hours. A signal is used over each traffic lane, and each signal has a red “X” indication and green “arrow” indication. The green arrow, when illuminated, advises that you may travel in that lane. The red “X,” when illuminated, advises that those lanes are being used by traffic traveling toward you and you may not use those lanes. These devices are used to provide additional lanes in the directions of heaviest travel in order to accommodate peak traffic.



72



73



74





Finding Your Local DMV



For More Information and Services

For more information, you may call us or visit our website.

SCDMV Contact Center:

(803) 896-5000

SCDMV Website:

www.scdmvonline.com

SCDMV Headquarters Offices:

10311 Wilson Boulevard
Post Office Box 1498
Blythewood, SC 29016

SCDMV OFFICE LOCATIONS

Abbeville DMV

1331 Haigler Street Extension
Abbeville, SC 29620

Aiken DMV

1755 Richland Avenue East
Aiken, SC 29801

Allendale DMV

3657 Allendale Fairfax Road
Fairfax, SC 29827
(Open Tuesday & Thursday Only)

Anderson DMV

331 29 By-Pass North
Anderson, SC 29621

Bamberg DMV

341 Lacey Street
Bamberg, SC 29003

Barnwell DMV

1270 Main Street
Barnwell, SC 29812

Batesburg DMV

509 Liberty Street
Batesburg, SC 29006

Beaufort DMV

28 Munch Drive
Beaufort, SC 29906

Belton DMV

123 O'Neal Street
Belton, SC 29627

Bennettsville DMV

337 Highway 9 West
Bennettsville, SC 29512

Bishopville DMV

508 South Lee Street
Bishopville, SC 29010

Bluffton DMV

15 Sheridan Park
Bluffton, SC 29910

Blythewood DMV

10311 Wilson Blvd.
Blythewood, SC 29016

Camden DMV

1056 Ehrenclou Drive
Camden, SC 29020

Charleston DMV

Ashley Oaks Plaza
1119-G Wapoo Road
Charleston, SC 29407

Charleston DMV

3790 Leeds Avenue
N. Charleston, SC 29405

Charleston DMV
180 Lockwood Blvd.
Charleston, SC 29403

Chester DMV
508 Belt Road
Chester, SC 29706

Chesterfield DMV
100 Laney Street
Chesterfield, SC 29709

Columbia DMV
1630 Shop Road
Columbia, SC 29201

Columbia DMV
2500 Decker Blvd.
Columbia, SC 29206

Columbia DMV
800 Dutch Square Blvd.
Building A, Suite 100
Columbia, SC 29210

Conway DMV
4103 Highway 701 North
Conway, SC 29526

Darlington DMV
2200 East Bobo Newsome Hwy
Hartsville, SC 29550

Dillon DMV
1705 Highway 301 South
Dillon, SC 29536-1705

Edgefield DMV
849 Highway 25 North
Edgefield, SC 29824

Florence DMV
3102 E. Palmetto Street
Florence, SC 29506

Fort Mill
3071 Highway 21, Suite 110
Fort Mill, SC 29715

Fountain Inn DMV
1310 North Main Street
Fountain Inn, SC 29644

Gaffney DMV
451 Hyatt Street
Gaffney, SC 29341

Georgetown DMV
214 Ridge Street
Georgetown, SC 29440

Greenville DMV
300 University Ridge Road, Suite 105
Greenville, SC 29601

Greenville DMV
15 Saluda Dam Road
Greenville, SC 29611

Greenwood DMV
510 W. Alexander Ext.
Greenwood, SC 29646

Greer DMV
610 Arlington Road
Greer, SC 29651

Hampton DMV
115 Cemetery Road
Varnville, SC 29944

Irmo-Ballentine DMV
1016 Broadstone Road
Irmo, SC 29063

Kingstree DMV
785 Eastland Avenue
Kingstree, SC 29556

Ladson DMV
135 Wimberly Drive
Ladson, SC 29456

Lake City DMV
728 South Ron McNair Blvd.
Lake City, SC 29560

Lancaster DMV
1694 Pageland Highway
Lancaster, SC 29720

Laurens DMV
390 Fairgrounds Road
Laurens, SC 29360

Lexington DMV
122 Park Road
Lexington, SC 29072

Manning DMV
3721 Alex Harvin Hwy
Manning, SC 29102

Marion DMV
2757 East Highway 76
Mullins, SC 29574

McCormick DMV
504 Airport Road
Suite A
McCormick, SC 29835

Moncks Corner DMV
438 North Highway 52
Moncks Corner, SC 29461

Mt. Pleasant DMV
1189 Sweetgrass Basket Pwy.
Suite 500
Mt. Pleasant, SC 29466

Myrtle Beach DMV
1200 21st Avenue North
Myrtle Beach, SC 29577

Newberry DMV
275 Mt. Bethel-Garmany Road
Newberry, SC 29108

North Augusta DMV
1711 Ascauga Lake Road
North Augusta, SC 29841

North Myrtle Beach DMV
107 Highway 57 North
Little River, SC 29566

Orangeburg DMV
1720 Charleston Highway
Orangeburg, SC 29115

Pickens DMV
2133 Gentry Memorial Hwy
Pickens, SC 29671

Ridgeland DMV
407 Live Oak Drive
Ridgeland, SC 29936

Rock Hill DMV
305 Hands Mill Road
Rock Hill, SC 29732

Saluda DMV
400 West Wheeler Circle
Saluda, SC 29138

Santee DMV
117 Dazzy Circle
Santee, SC 29142
(Open Tuesday & Thursday only)

Seneca DMV
13009 South Radio Station Road
Seneca, SC 29678

Spartanburg DMV
8794 Fairforest Road, Suite B
Spartanburg, SC 29303-4722

Spartanburg DMV
1625 Southport Road
Spartanburg, SC 29306

St. George DMV
5315 E. Jim Bilton Blvd.
St. George, SC 29477

St. Matthews DMV
415 Chestnut Street
St. Matthews, SC 29135

Sumter DMV
430 South Pike Street, East
Sumter, SC 29150

Union DMV
1000 North Pickney Street
Union, SC 29379

Walterboro DMV
102 Mable T. Willis Blvd.
Walterboro, SC 29488-4500

Winnsboro DMV
1161 Kincaid Bridge Road
Winnsboro, SC 29180

Woodruff DMV
351 South Main Street
Woodruff, SC 29388

**DMV OFFICES THAT SERVE
INTERNATIONAL CUSTOMERS**

Bluffton DMV

15 Sheridan Park
Bluffton, SC 29910

Charleston DMV

3790 Leeds Avenue
N. Charleston, SC 29405

Columbia DMV

1630 Shop Road
Columbia, SC 29201

Conway DMV

4103 Highway 701 North
Conway, SC 29526

Florence DMV

3102 E. Palmetto Street
Florence, SC 29506

Greenville DMV

15 Saluda Dam Road
Greenville, SC 29611

Greenwood DMV

510 W. Alexander Ext.
Greenwood, SC 29646

Irmo-Ballentine DMV

1016 Broadstone Road
Irmo, SC 29063

Lancaster DMV

1694 Pageland Highway
Lancaster, SC 29720

Laurens DMV

390 Fairgrounds Road
Laurens, SC 29360

Myrtle Beach DMV

1200 21st Avenue North
Myrtle Beach, SC 29577

North Augusta DMV

1711 Ascauga Lake Road
North Augusta, SC 29841

Orangeburg DMV

1720 Charleston Highway
Orangeburg, SC 29115

Rock Hill DMV

305 Hands Mill Road
Rock Hill, SC 29732

Seneca DMV

13009 South Radio Station Road
Seneca, SC 29678

Spartanburg DMV

1625 Southport Road
Spartanburg, SC 29306

NOTES

200

250000/139340/.5574